

**William Stallings  
Computer Organization  
and Architecture  
10<sup>th</sup> Edition**



# + Chapter 3

## A Top-Level View of Computer Function and Interconnection



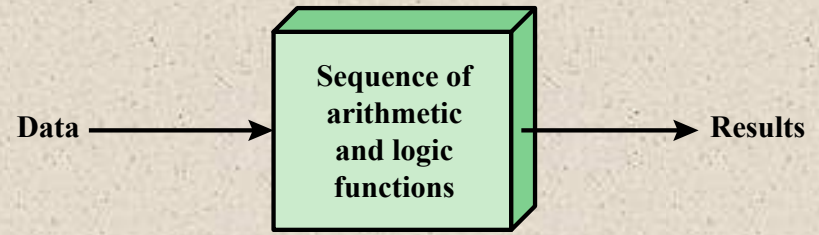
# Computer Components



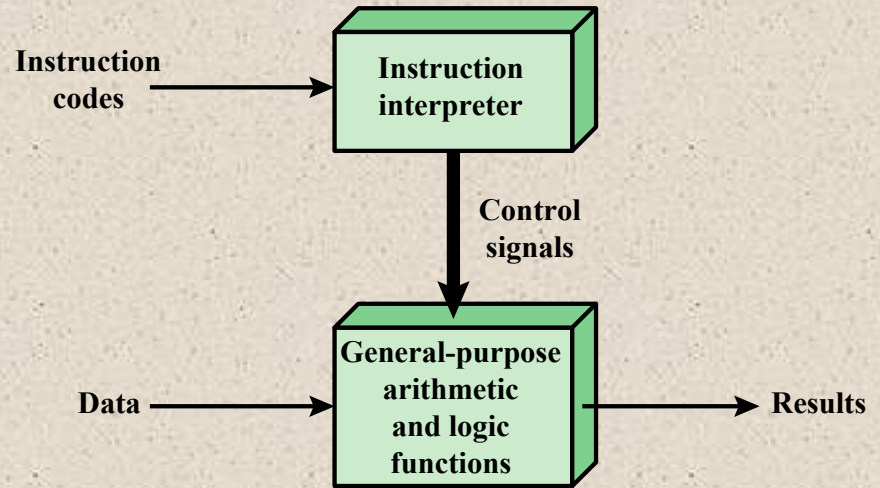
- Contemporary computer designs are based on concepts developed by John von Neumann at the Institute for Advanced Studies, Princeton
- Referred to as the *von Neumann architecture* and is based on three key concepts:
  - Data and instructions are stored in a single read-write memory
  - The contents of this memory are addressable by location, without regard to the type of data contained there
  - Execution occurs in a sequential fashion (unless explicitly modified) from one instruction to the next
- *Hardwired program*
  - The result of the process of connecting the various components in the desired configuration



# Hardware and Software Approaches



(a) Programming in hardware



(b) Programming in software

**Figure 3.1 Hardware and Software Approaches**

# Software

- A sequence of codes or instructions
- Part of the hardware interprets each instruction and generates control signals
- Provide a new sequence of codes for each new program instead of rewiring the hardware

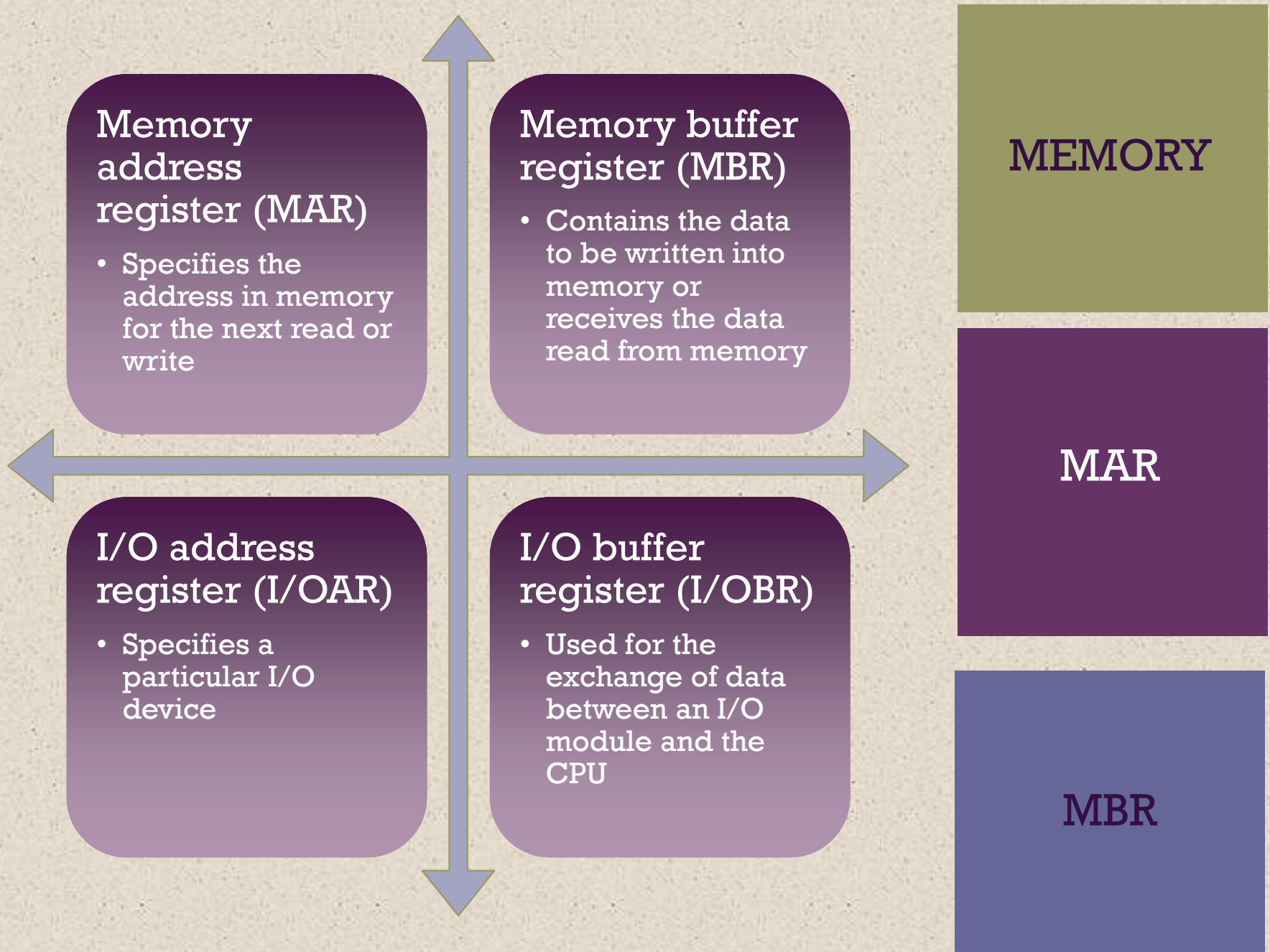
## Major components:

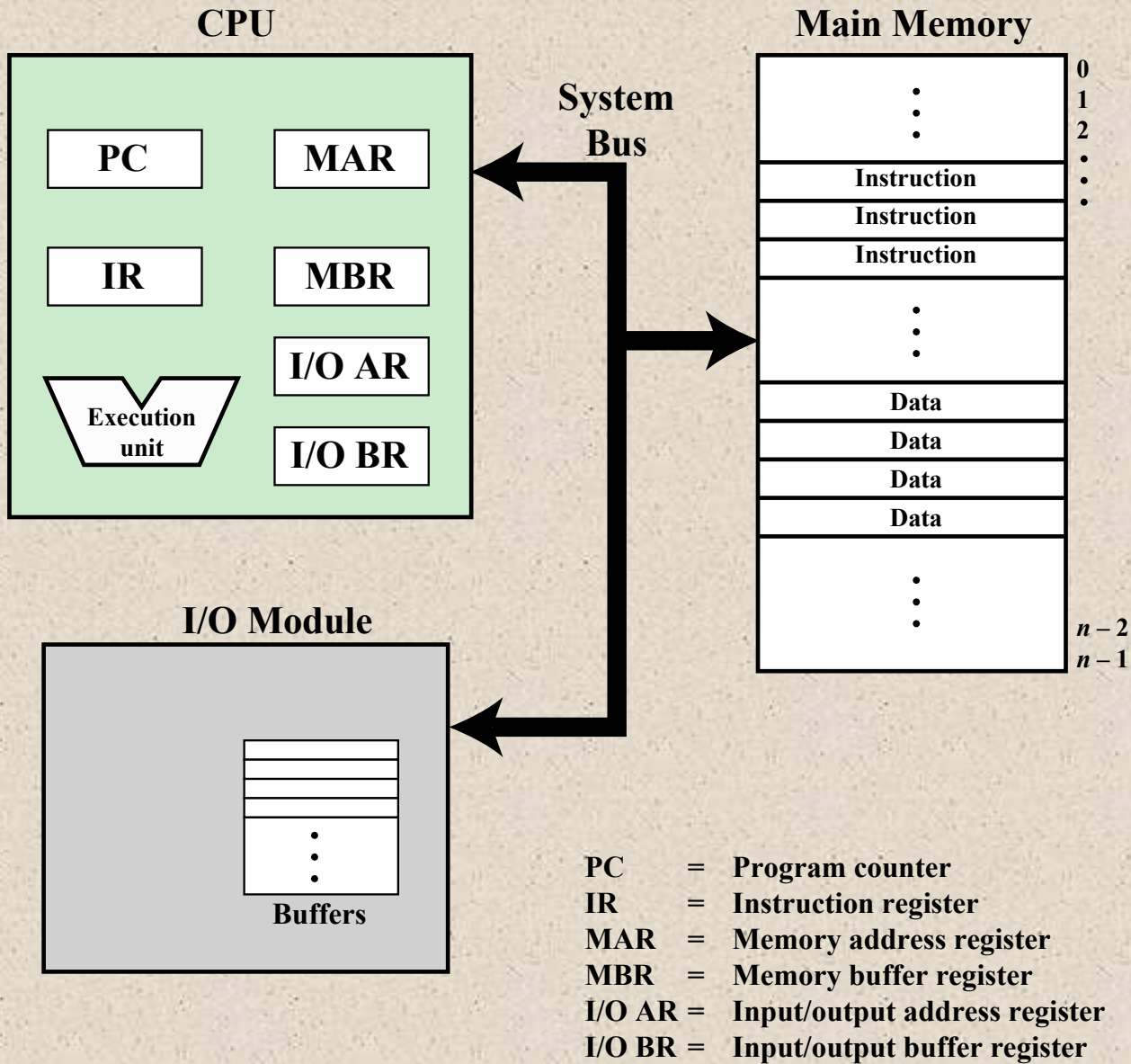
- CPU
  - Instruction interpreter
  - Module of general-purpose arithmetic and logic functions
- I/O Components
  - Input module
    - Contains basic components for accepting data and instructions and converting them into an internal form of signals usable by the system
  - Output module
    - Means of reporting results

Software

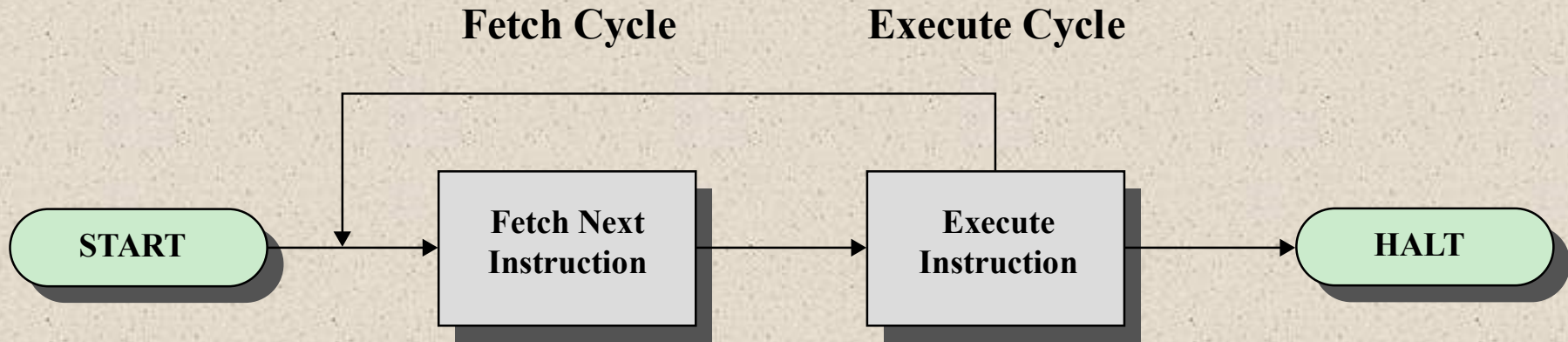
I/O  
Components







**Figure 3.2 Computer Components: Top-Level View**



**Figure 3.3 Basic Instruction Cycle**





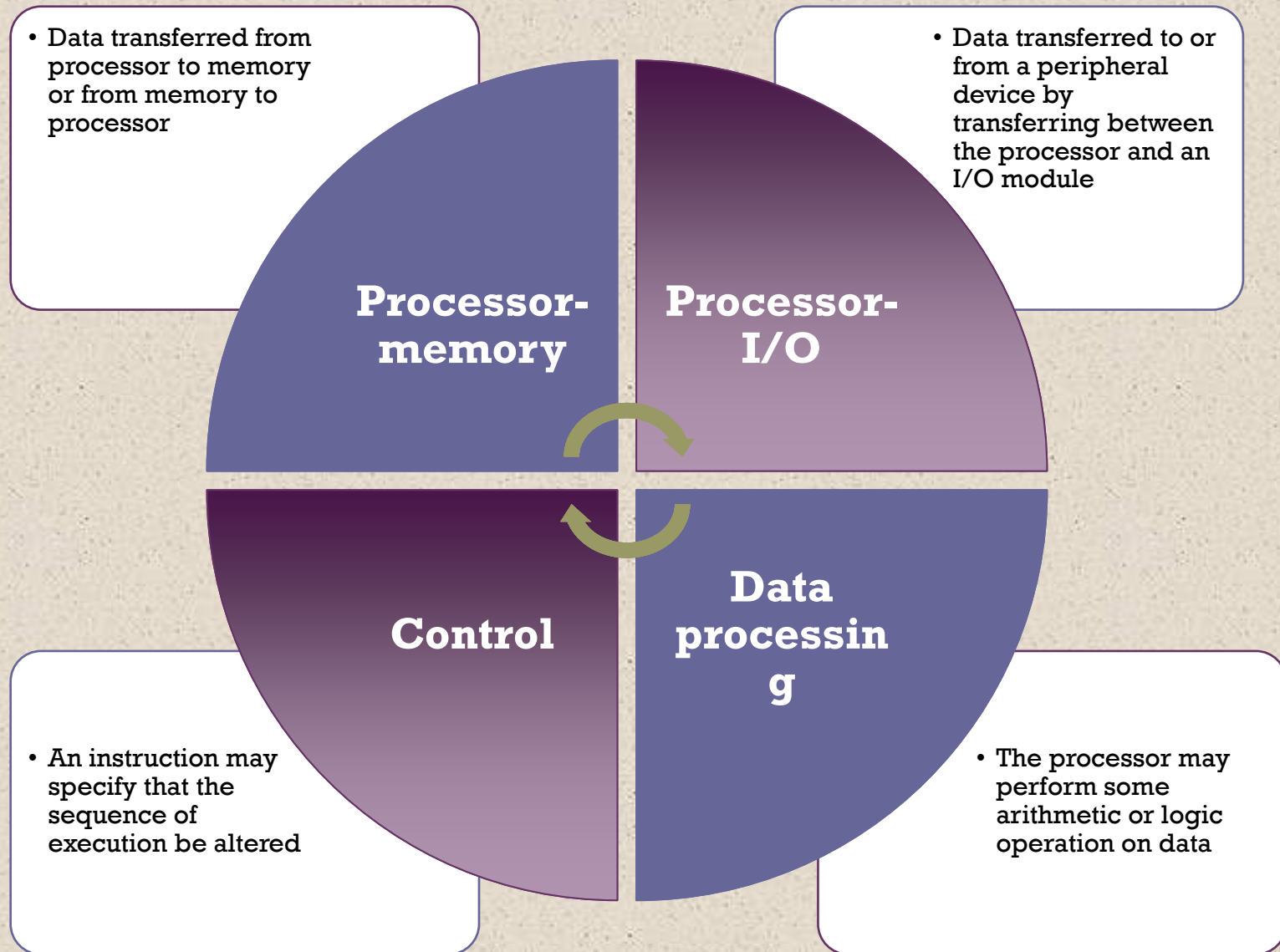
# Fetch Cycle



- At the beginning of each instruction cycle the processor fetches an instruction from memory
- The program counter (PC) holds the address of the instruction to be fetched next
- The processor increments the PC after each instruction fetch so that it will fetch the next instruction in sequence
- The fetched instruction is loaded into the instruction register (IR)
- The processor interprets the instruction and performs the required action



# Action Categories





(a) Instruction format



(b) Integer format

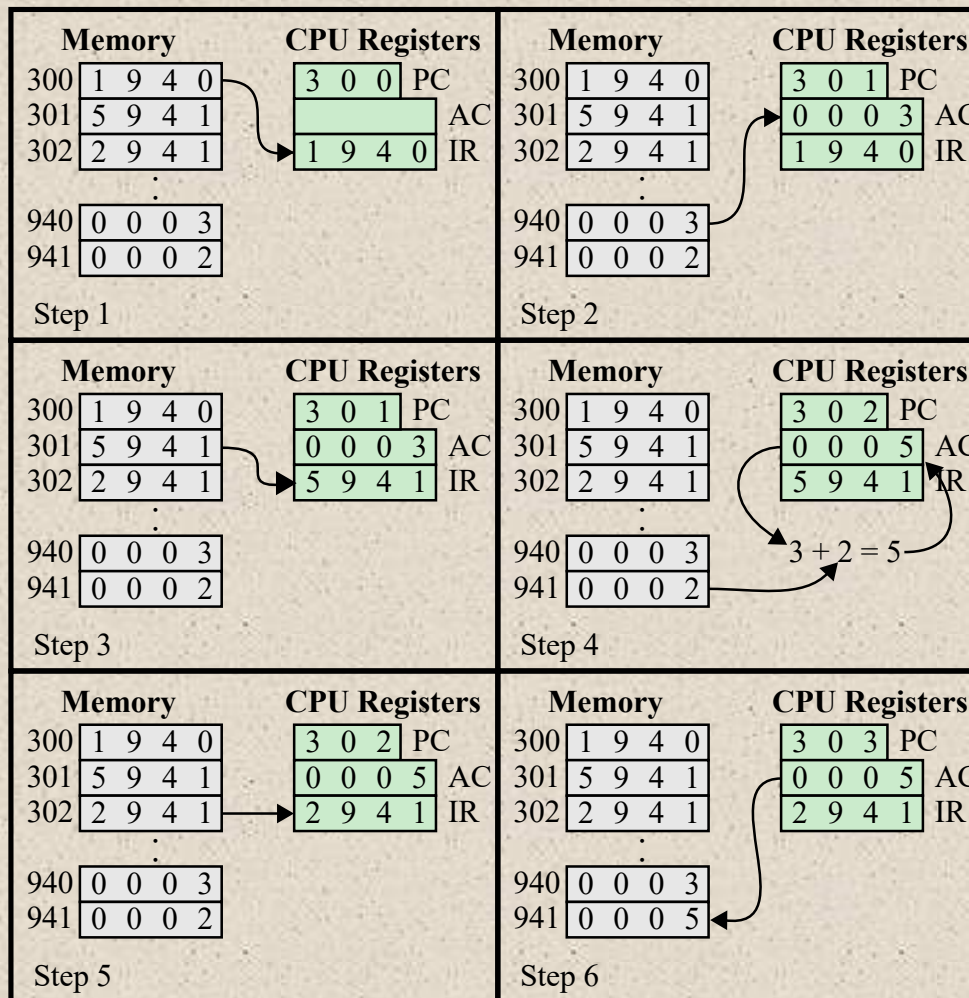
Program Counter (PC) = Address of instruction  
 Instruction Register (IR) = Instruction being executed  
 Accumulator (AC) = Temporary storage

(c) Internal CPU registers

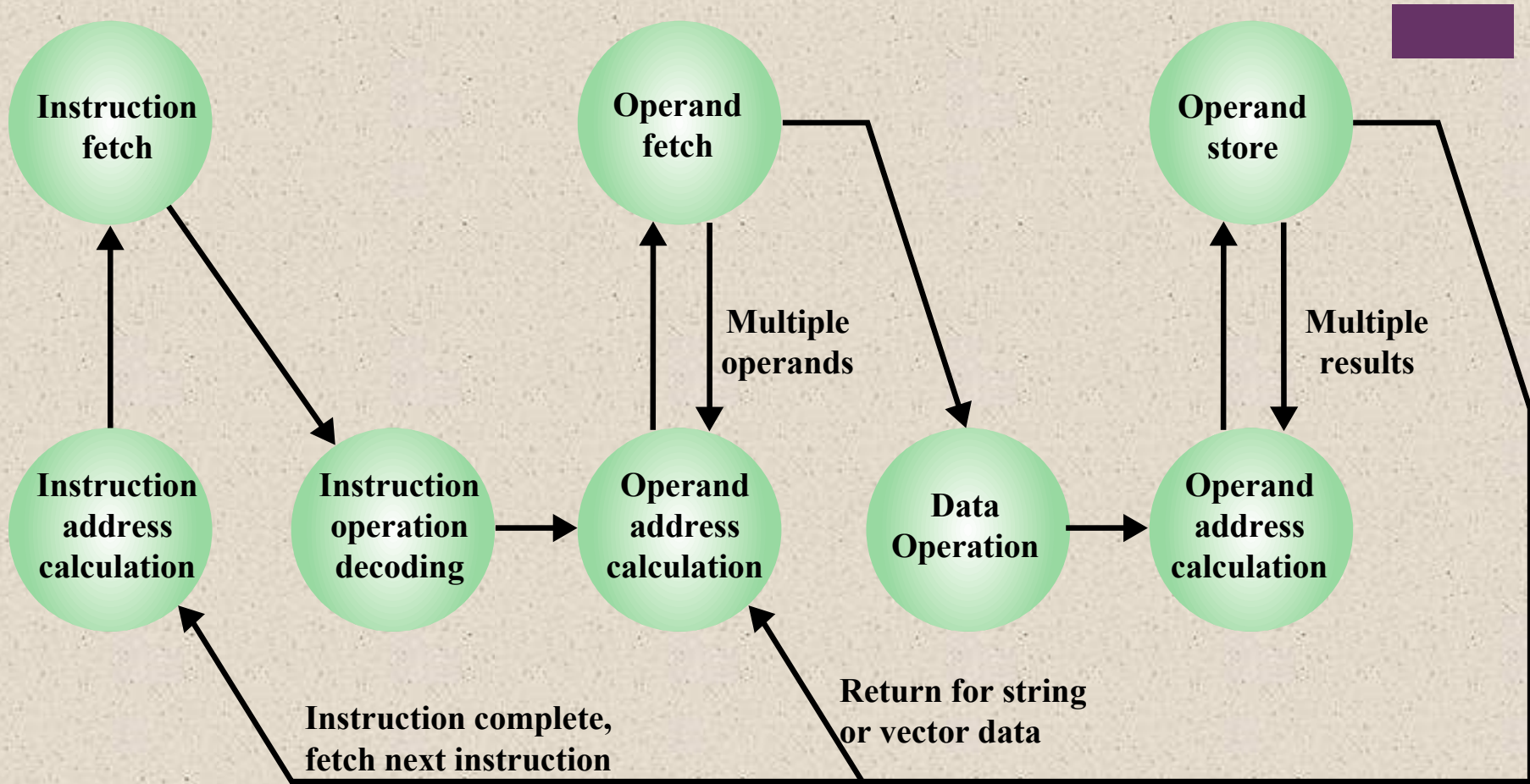
0001 = Load AC from Memory  
 0010 = Store AC to Memory  
 0101 = Add to AC from Memory

(d) Partial list of opcodes

**Figure 3.4 Characteristics of a Hypothetical Machine**



**Figure 3.5 Example of Program Execution  
(contents of memory and registers in hexadecimal)**



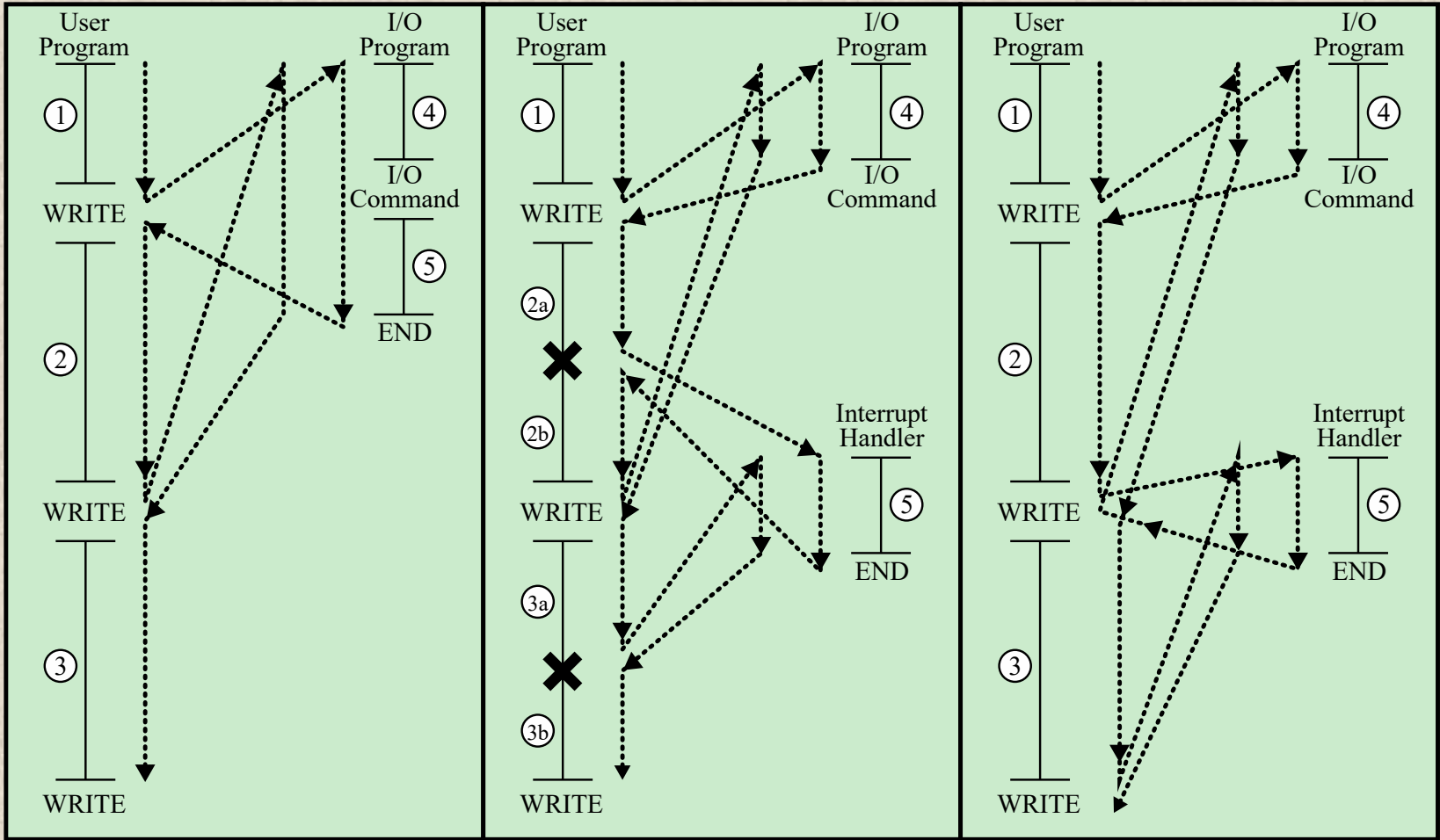
**Figure 3.6 Instruction Cycle State Diagram**



<b>Program</b>	Generated by some condition that occurs as a result of an instruction execution, such as arithmetic overflow, division by zero, attempt to execute an illegal machine instruction, or reference outside a user's allowed memory space.
<b>Timer</b>	Generated by a timer within the processor. This allows the operating system to perform certain functions on a regular basis.
<b>I/O</b>	Generated by an I/O controller, to signal normal completion of an operation, request service from the processor, or to signal a variety of error conditions.
<b>Hardware failure</b>	Generated by a failure such as power failure or memory parity error.

**Table 3.1**

**Classes of Interrupts**



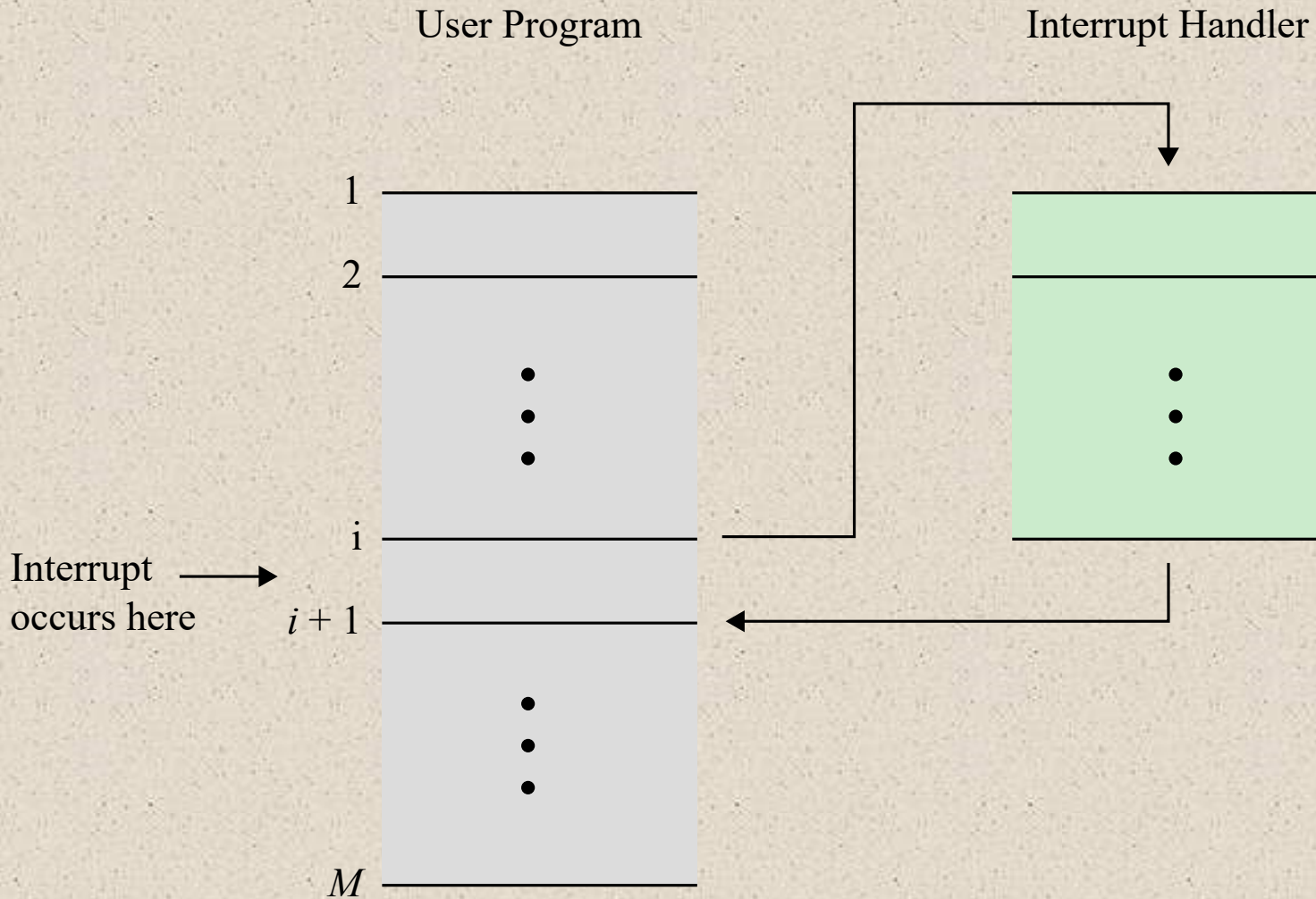
(a) No interrupts

(b) Interrupts; short I/O wait

(c) Interrupts; long I/O wait

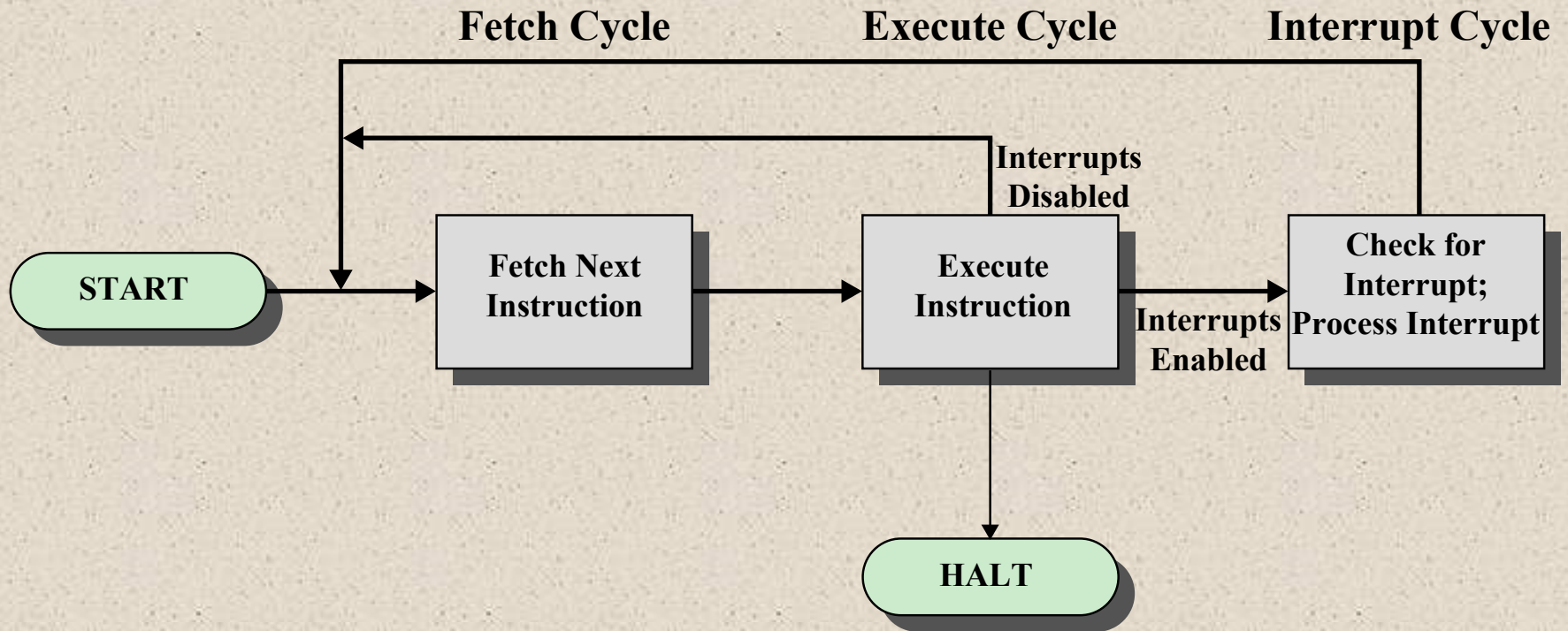
✘ = interrupt occurs during course of execution of user program

**Figure 3.7 Program Flow of Control Without and With Interrupts**

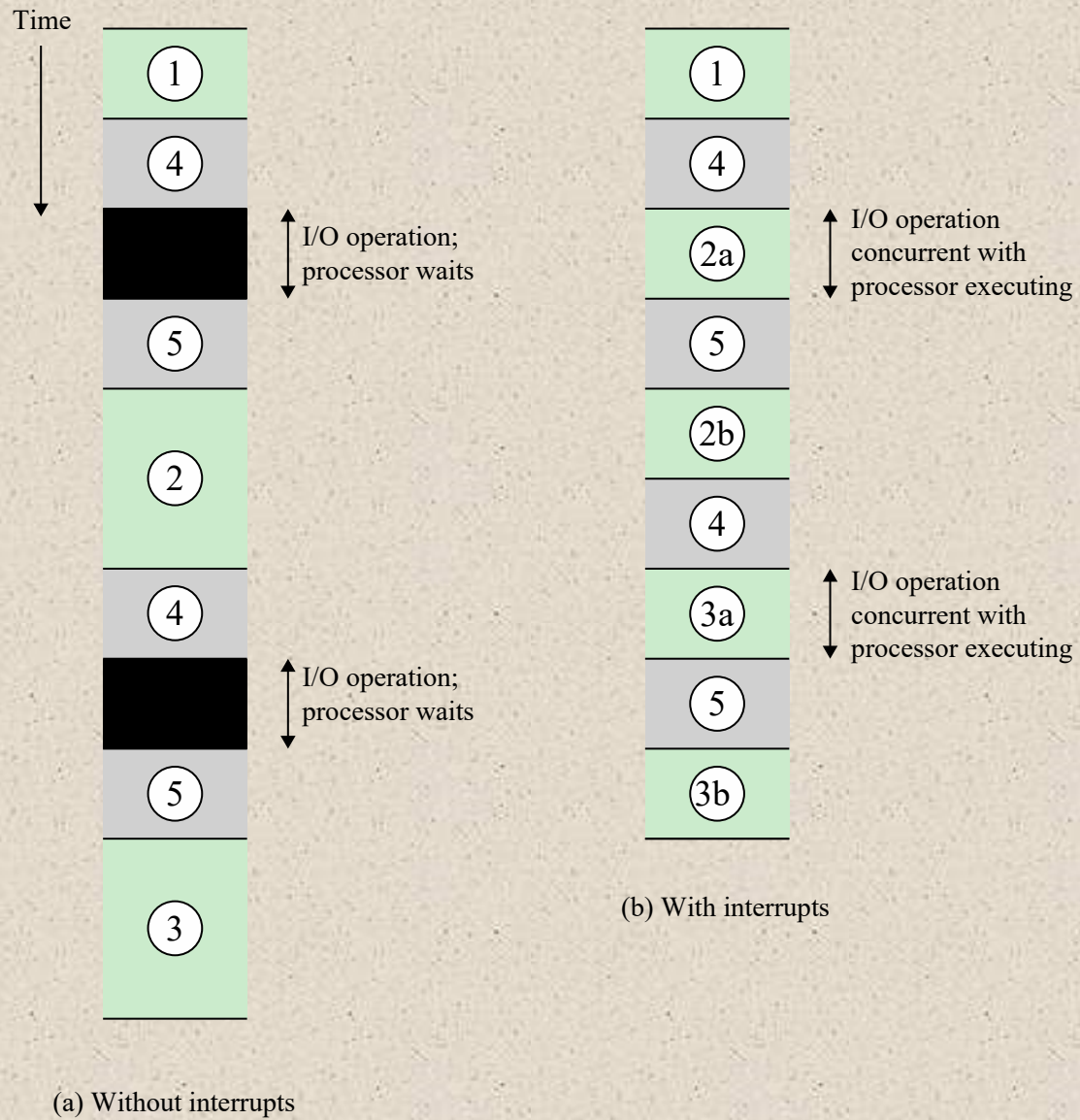


**Figure 3.8 Transfer of Control via Interrupts**

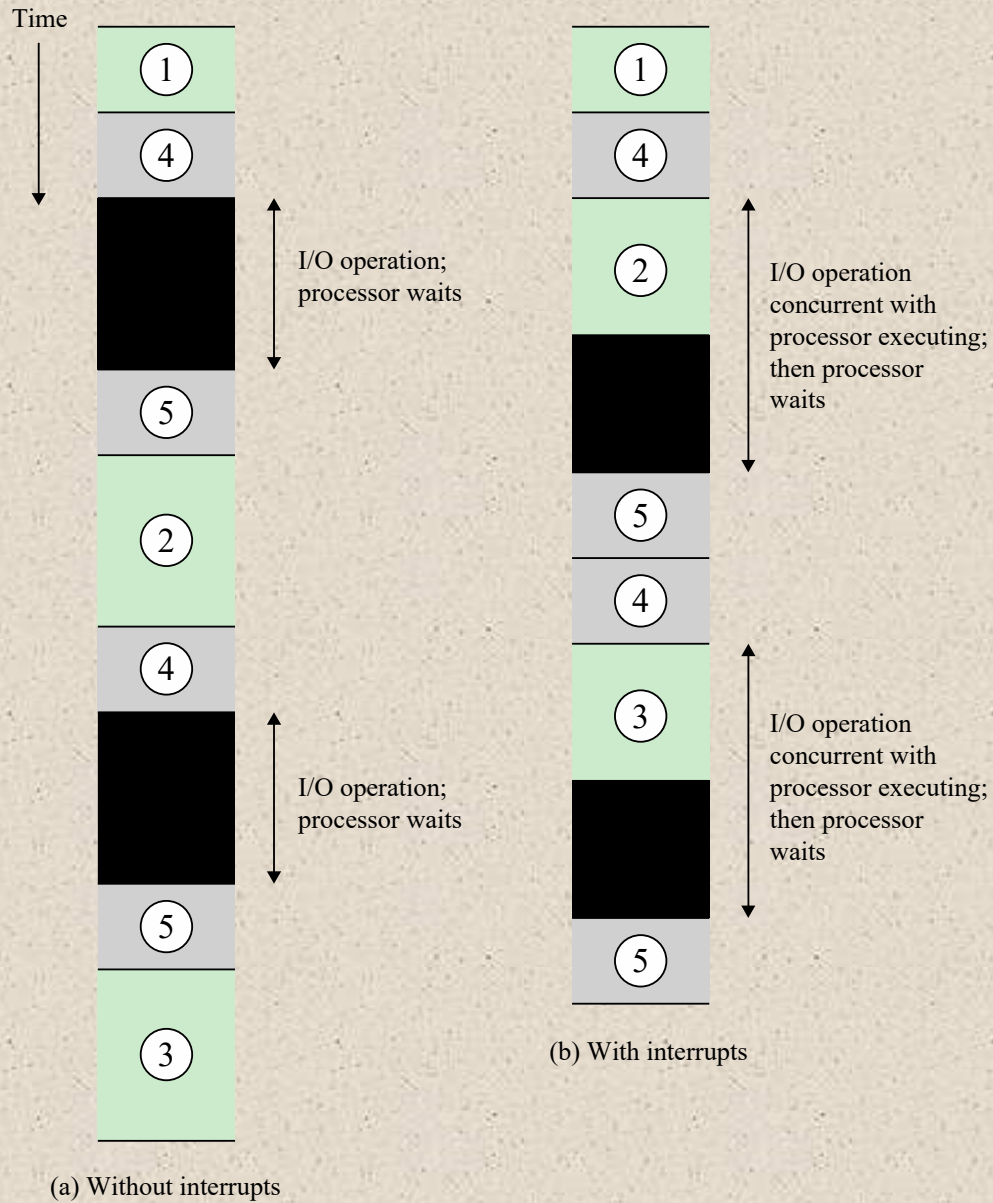




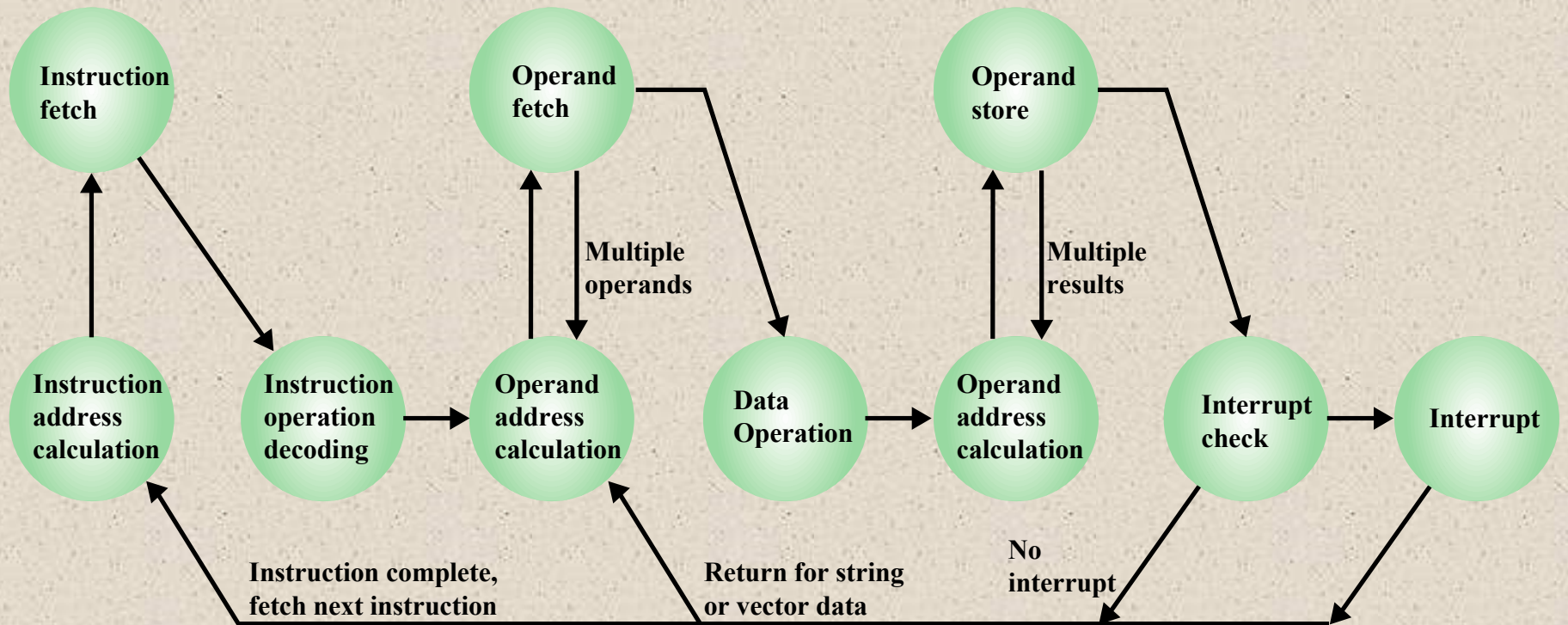
**Figure 3.9 Instruction Cycle with Interrupts**



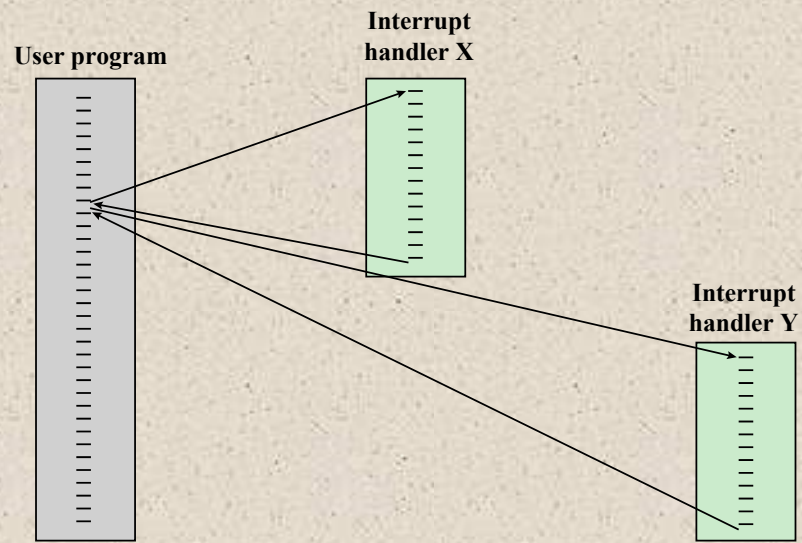
**Figure 3.10 Program Timing: Short I/O Wait**



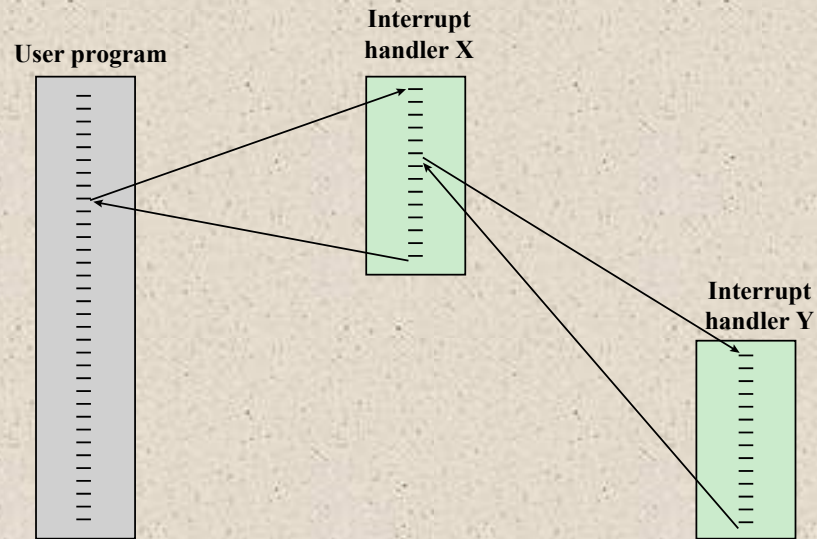
**Figure 3.11 Program Timing: Long I/O Wait**



**Figure 3.12 Instruction Cycle State Diagram, With Interrupts**

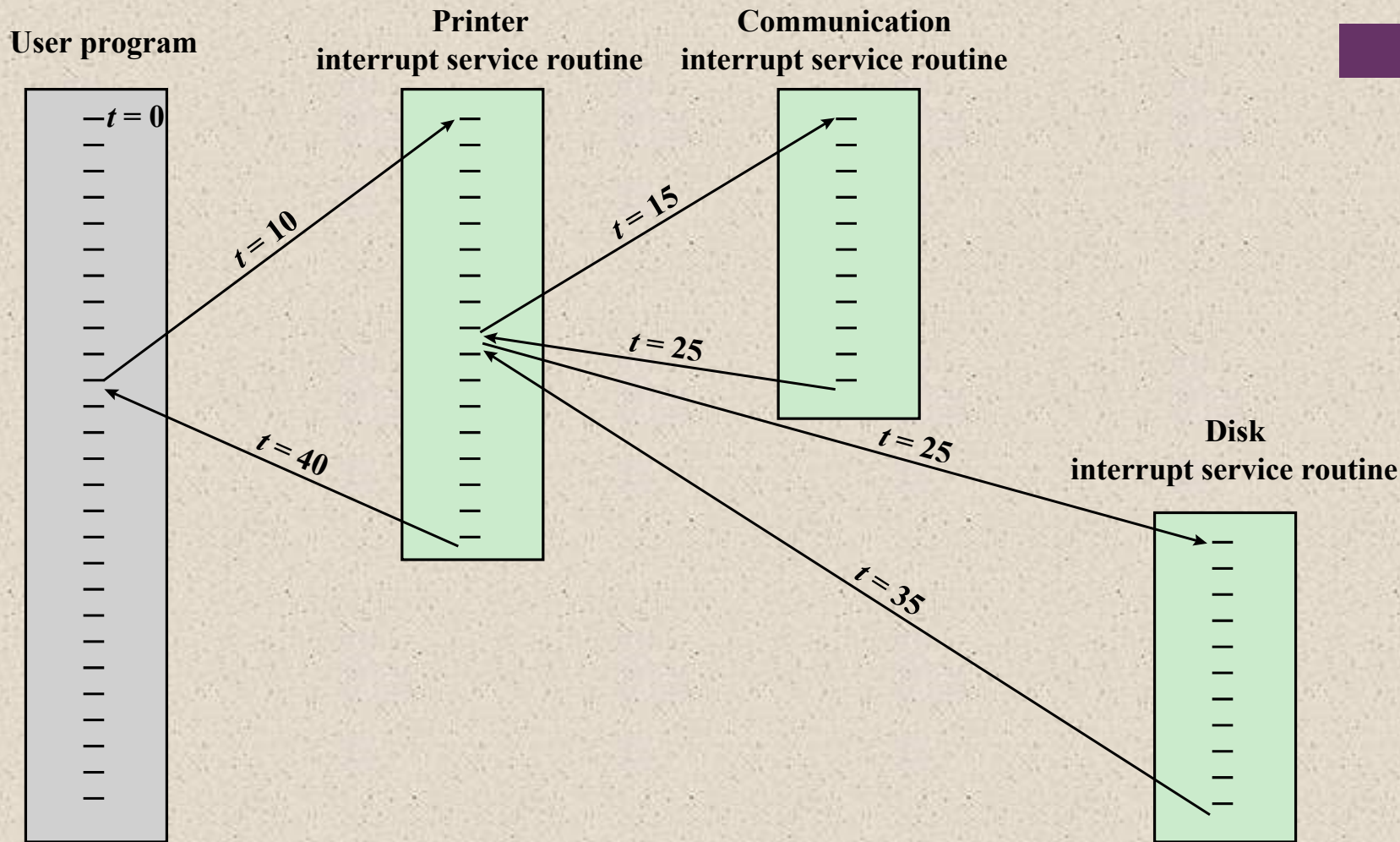


(a) Sequential interrupt processing



(b) Nested interrupt processing

**Figure 3.13 Transfer of Control with Multiple Interrupts**

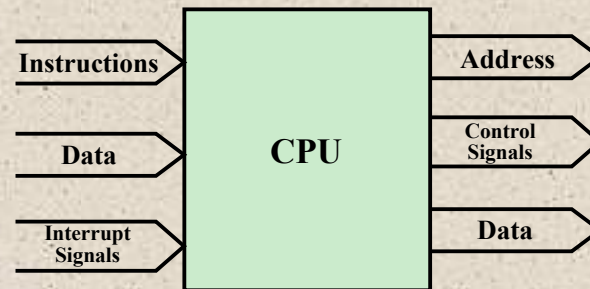
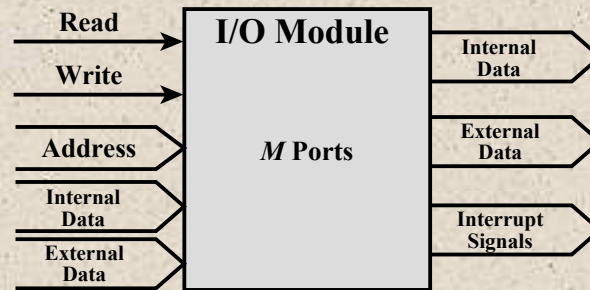
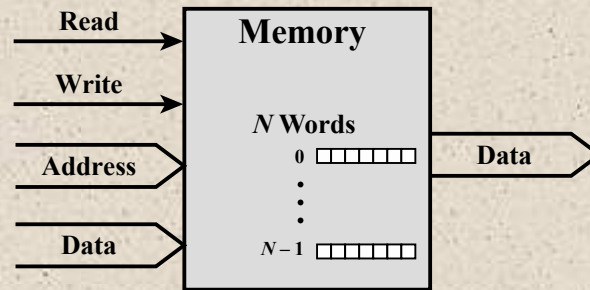


**Figure 3.14 Example Time Sequence of Multiple Interrupts**



# I/O Function

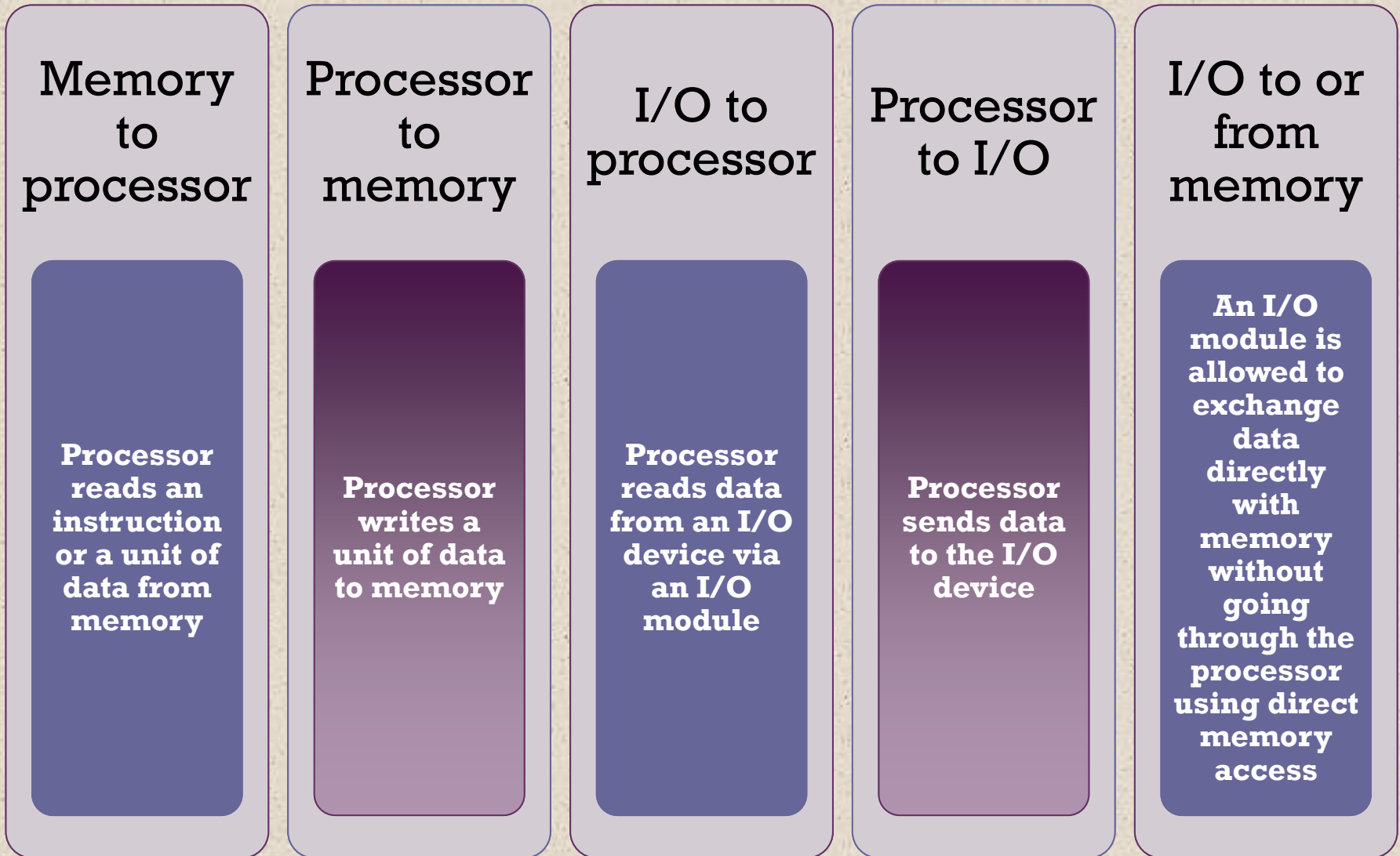
- I/O module can exchange data directly with the processor
- Processor can read data from or write data to an I/O module
  - Processor identifies a specific device that is controlled by a particular I/O module
  - I/O instructions rather than memory referencing instructions
- In some cases it is desirable to allow I/O exchanges to occur directly with memory
  - The processor grants to an I/O module the authority to read from or write to memory so that the I/O memory transfer can occur without tying up the processor
  - The I/O module issues read or write commands to memory relieving the processor of responsibility for the exchange
  - This operation is known as direct memory access (DMA)



**Figure 3.15 Computer Modules**



# The interconnection structure must support the following types of transfers:



A communication pathway connecting two or more devices

- Key characteristic is that it is a shared transmission medium

Signals transmitted by any one device are available for reception by all other devices attached to the bus

- If two devices transmit during the same time period their signals will overlap and become garbled



Typically consists of multiple communication lines

- Each line is capable of transmitting signals representing binary 1 and binary 0

Computer systems contain a number of different buses that provide pathways between components at various levels of the computer system hierarchy



### *System bus*

- A bus that connects major computer components (processor, memory, I/O)

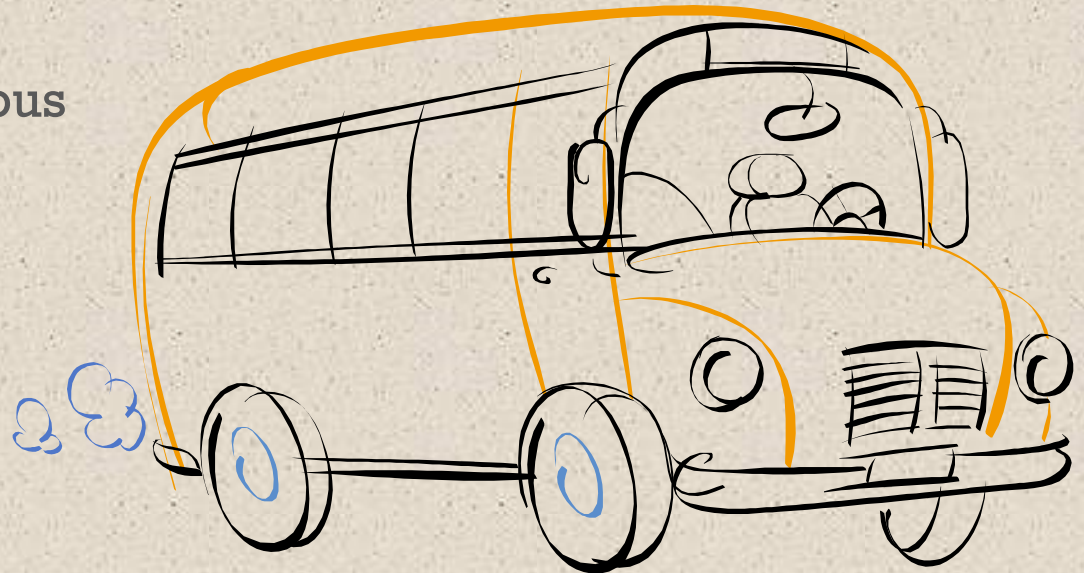
The most common computer interconnection structures are based on the use of one or more system buses

# Interconnection Bus Systems

# Data Bus



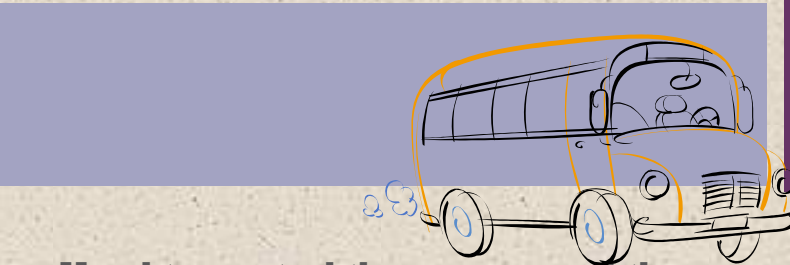
- Data lines that provide a path for moving data among system modules
- May consist of 32, 64, 128, or more separate lines
- The number of lines is referred to as the *width* of the data bus
- The number of lines determines how many bits can be transferred at a time
- The width of the data bus is a key factor in determining overall system performance



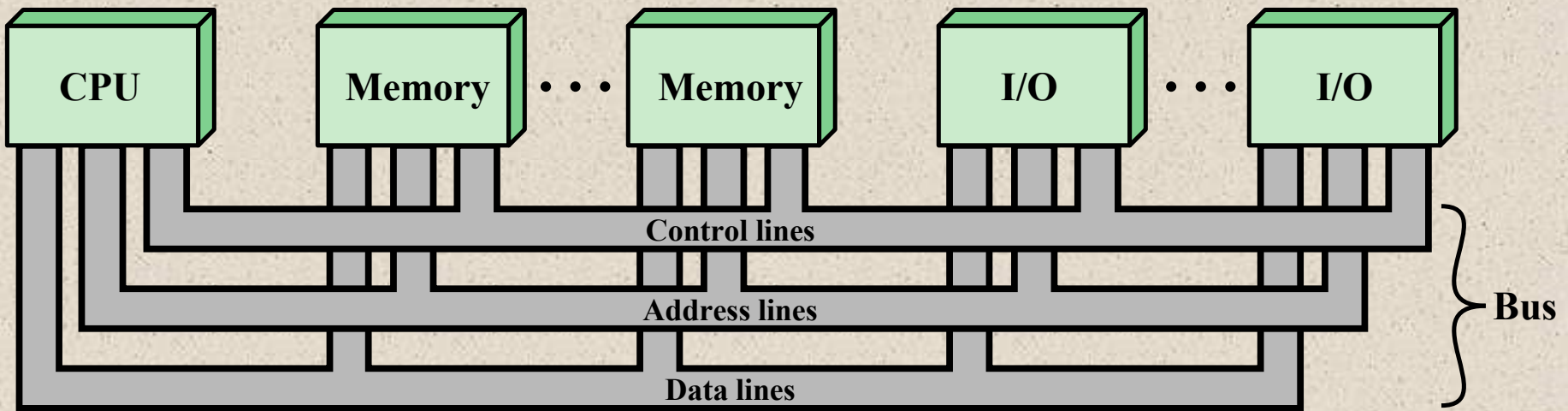
# + Address Bus

# Control Bus

- Used to designate the source or destination of the data on the data bus
  - If the processor wishes to read a word of data from memory it puts the address of the desired word on the address lines
- Width determines the maximum possible memory capacity of the system
- Also used to address I/O ports
  - The higher order bits are used to select a particular module on the bus and the lower order bits select a memory location or I/O port within the module



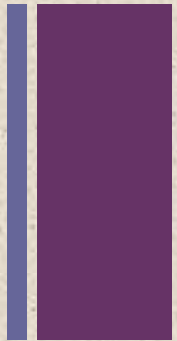
- Used to control the access and the use of the data and address lines
- Because the data and address lines are shared by all components there must be a means of controlling their use
- Control signals transmit both command and timing information among system modules
- Timing signals indicate the validity of data and address information
- Command signals specify operations to be performed



**Figure 3.16 Bus Interconnection Scheme**



# Point-to-Point Interconnect



Principal reason for change was the electrical constraints encountered with increasing the frequency of wide synchronous buses

At higher and higher data rates it becomes increasingly difficult to perform the synchronization and arbitration functions in a timely fashion

A conventional shared bus on the same chip magnified the difficulties of increasing bus data rate and reducing bus latency to keep up with the processors

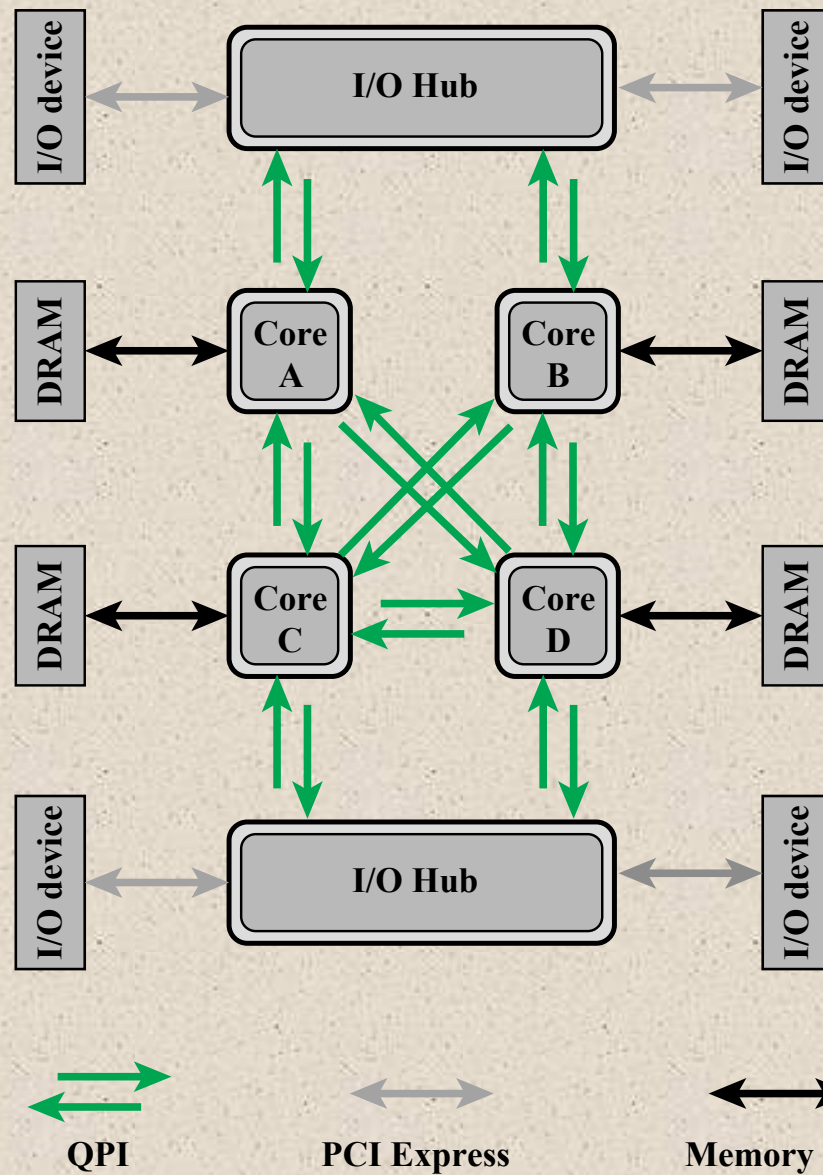
Has lower latency, higher data rate, and better scalability

# + Quick Path Interconnect

- Introduced in 2008
- Multiple direct connections
  - Direct pairwise connections to other components eliminating the need for arbitration found in shared transmission systems
- Layered protocol architecture
  - These processor level interconnects use a layered protocol architecture rather than the simple use of control signals found in shared bus arrangements
- Packetized data transfer
  - Data are sent as a sequence of packets each of which includes control headers and error control codes

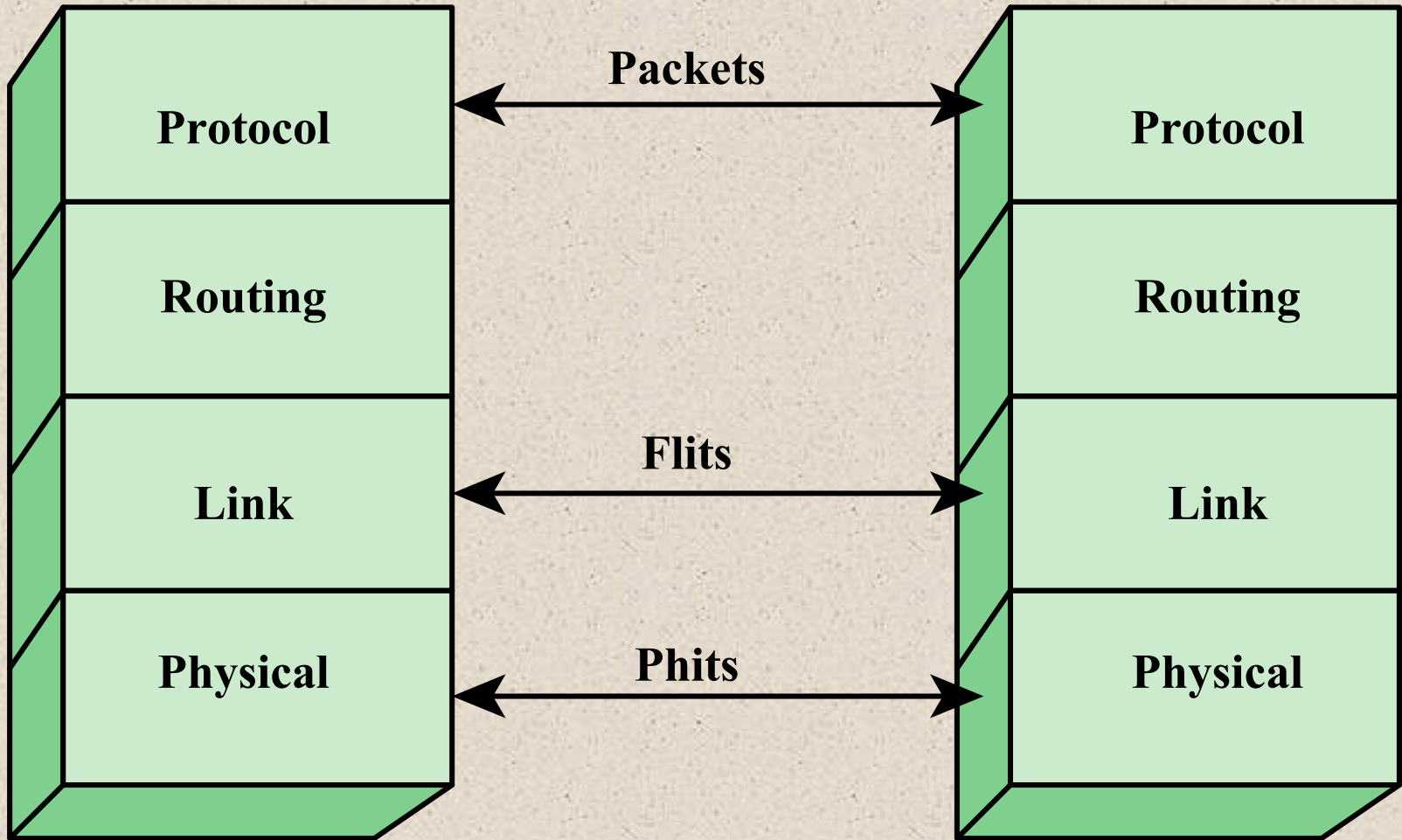
QPI



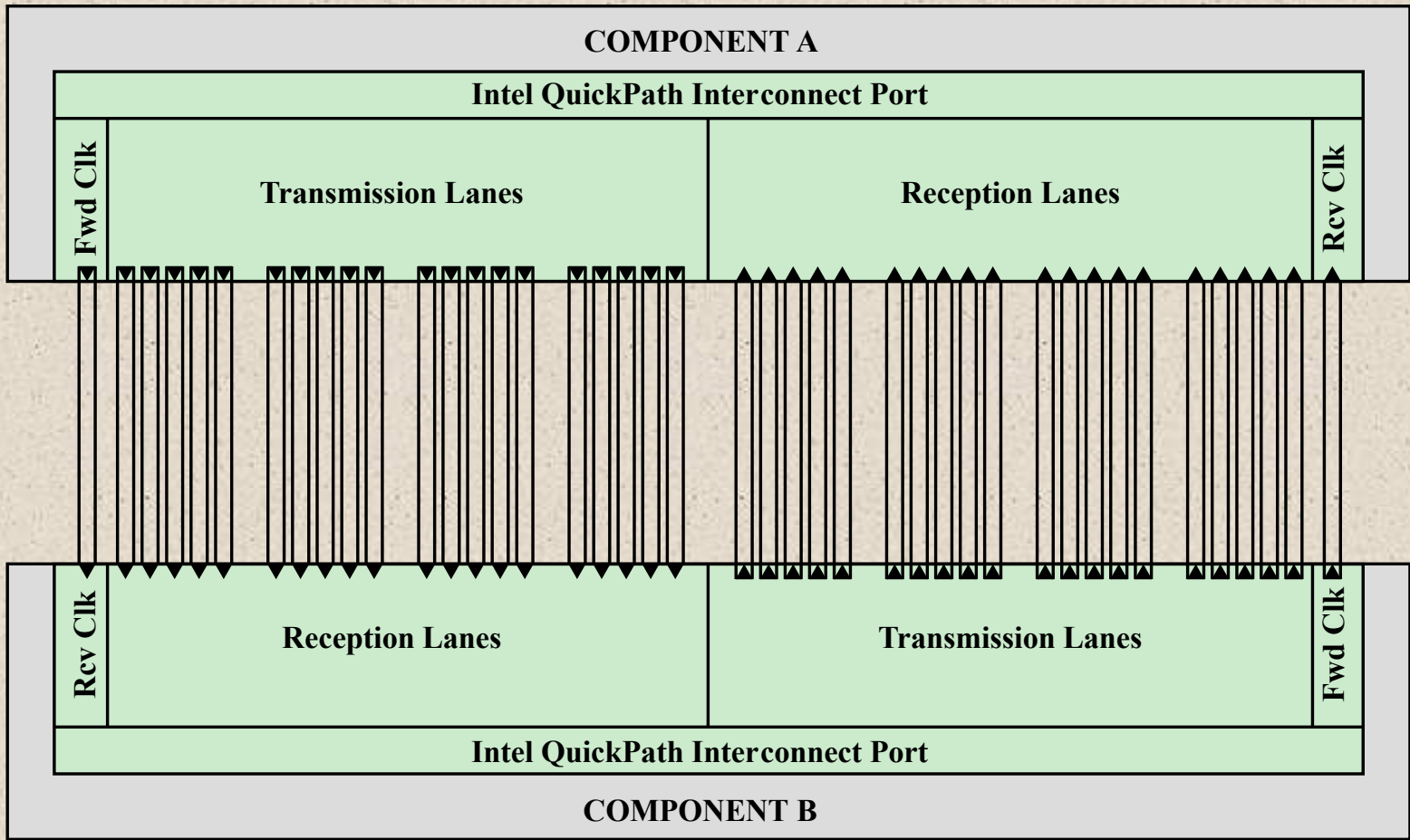


**Figure 3.17 Multicore Configuration Using QPI**

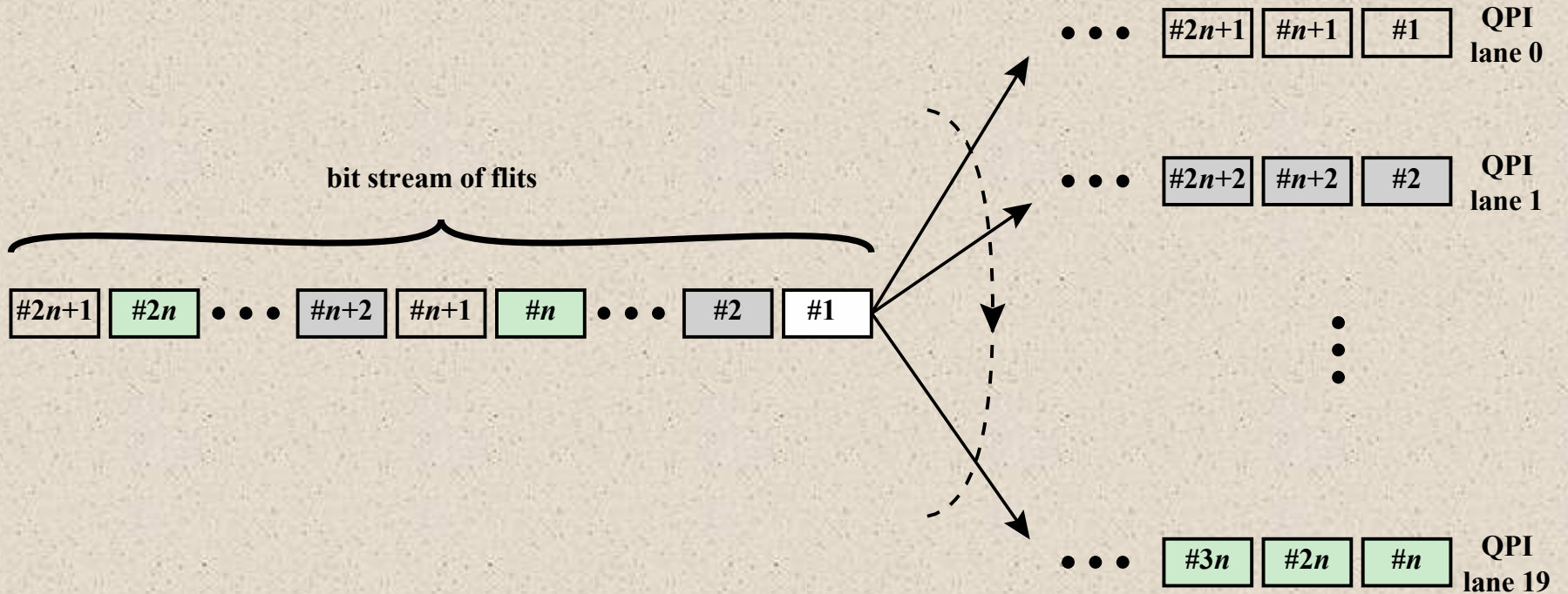




**Figure 3.18 QPI Layers**



**Figure 3.19 Physical Interface of the Intel QPI Interconnect**



**Figure 3.20 QPI Multilane Distribution**



# QPI Link Layer



- Performs two key functions: *flow control* and *error control*
  - Operate on the level of the flit (flow control unit)
  - Each flit consists of a 72-bit message payload and an 8-bit error control code called a *cyclic redundancy check* (CRC)
- Flow control function
  - Needed to ensure that a sending QPI entity does not overwhelm a receiving QPI entity by sending data faster than the receiver can process the data and clear buffers for more incoming data
- Error control function
  - Detects and recovers from bit errors, and so isolates higher layers from experiencing bit errors



# QPI Routing and Protocol Layers

## Routing Layer

- Used to determine the course that a packet will traverse across the available system interconnects
- Defined by firmware and describe the possible paths that a packet can follow

## Protocol Layer

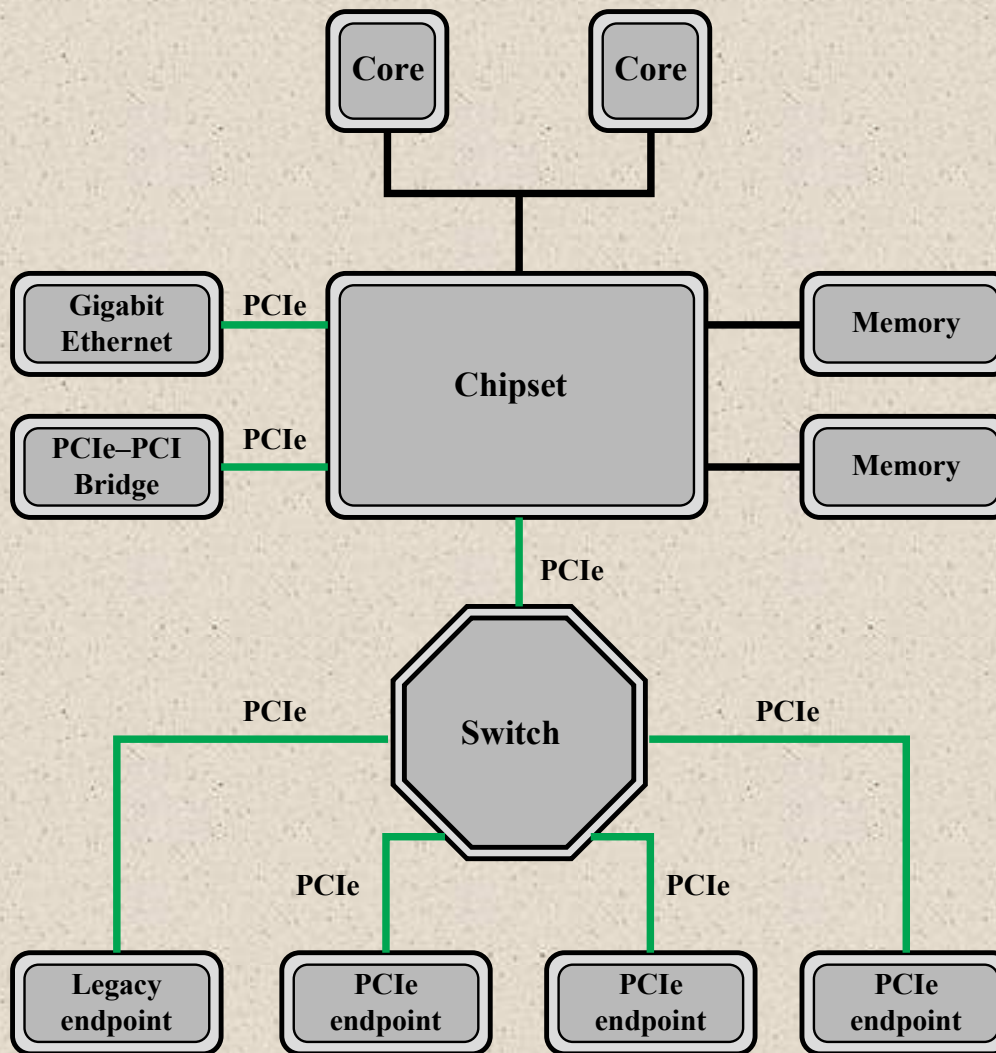
- Packet is defined as the unit of transfer
- One key function performed at this level is a cache coherency protocol which deals with making sure that main memory values held in multiple caches are consistent
- A typical data packet payload is a block of data being sent to or from a cache



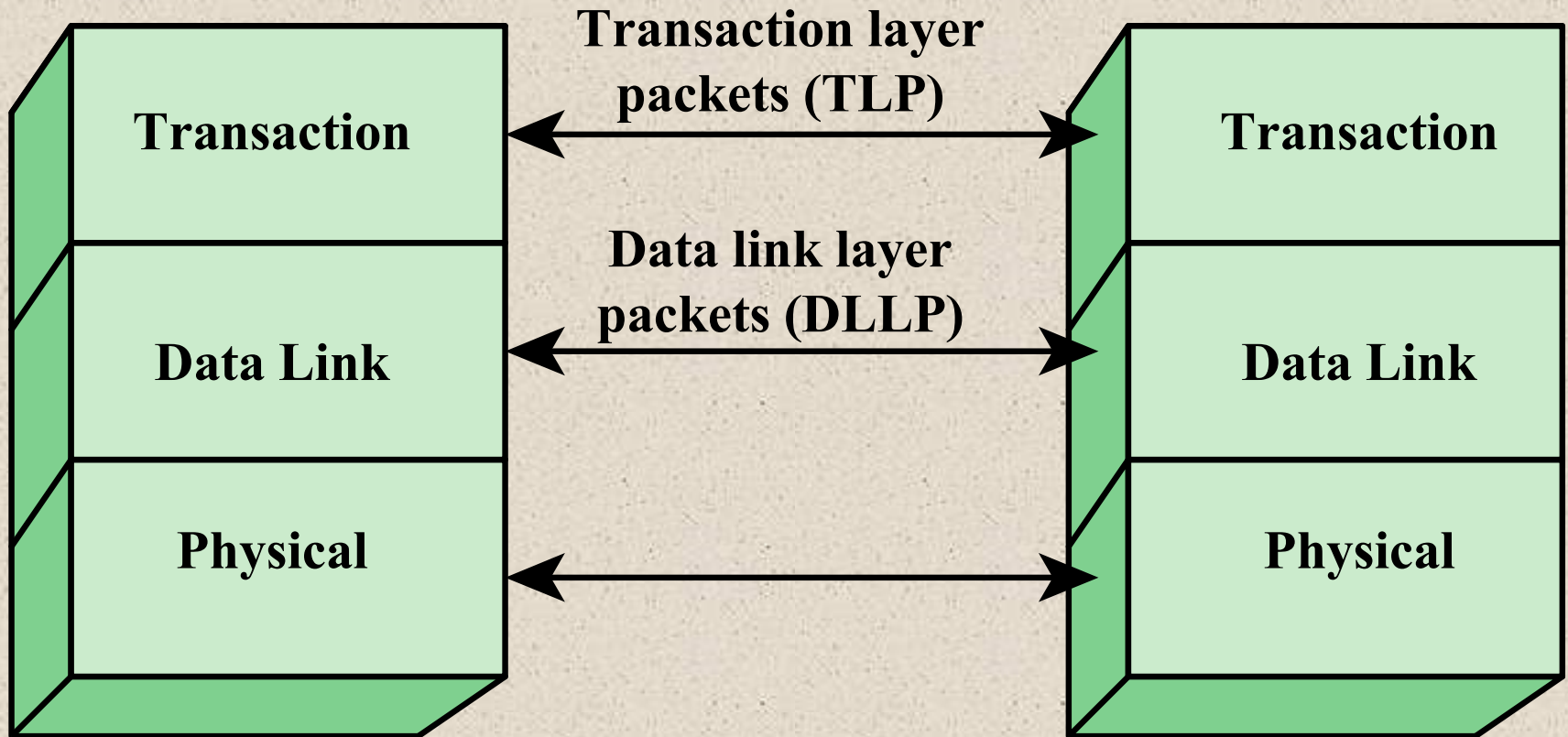
# Peripheral Component Interconnect (PCI)



- A popular high bandwidth, processor independent bus that can function as a mezzanine or peripheral bus
- Delivers better system performance for high speed I/O subsystems
- PCI Special Interest Group (SIG)
  - Created to develop further and maintain the compatibility of the PCI specifications
- PCI Express (PCIe)
  - Point-to-point interconnect scheme intended to replace bus-based schemes such as PCI
  - Key requirement is high capacity to support the needs of higher data rate I/O devices, such as Gigabit Ethernet
  - Another requirement deals with the need to support time dependent data streams

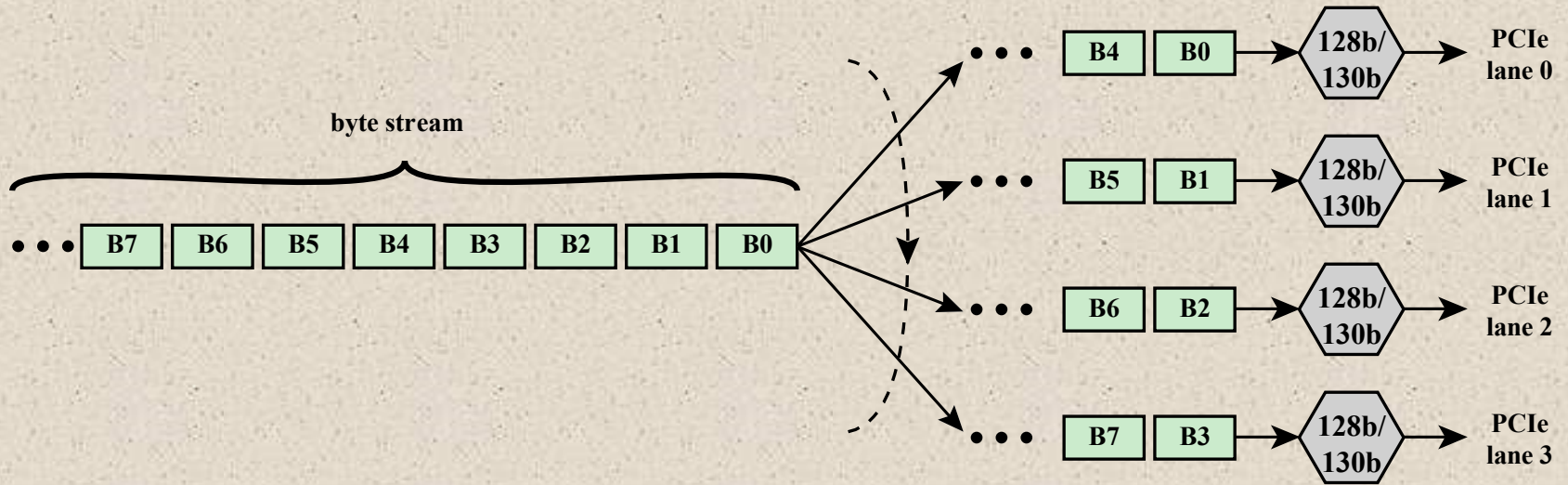


**Figure 3.21 Typical Configuration Using PCIe**

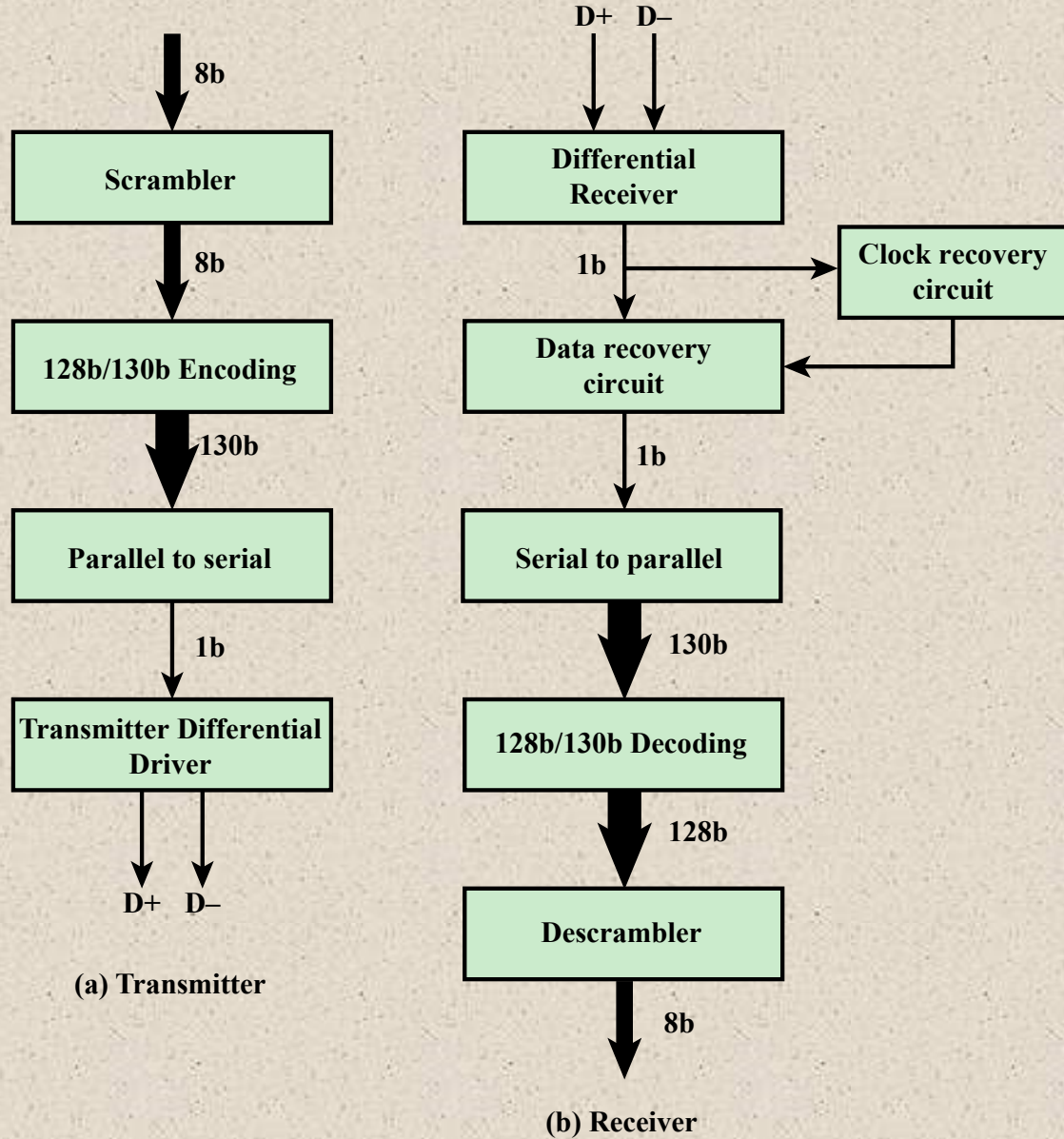


**Figure 3.22 PCIe Protocol Layers**





**Figure 3.23 PCIe Multilane Distribution**



**Figure 3.24 PCIe Transmit and Receive Block Diagrams**



## PCIe

### Transaction Layer (TL)



- Receives read and write requests from the software above the TL and creates request packets for transmission to a destination via the link layer
- Most transactions use a *split transaction* technique
  - A request packet is sent out by a source PCIe device which then waits for a response called a *completion* packet
- TL messages and some write transactions are posted transactions (meaning that no response is expected)
- TL packet format supports 32-bit memory addressing and extended 64-bit memory addressing



# The TL supports four address spaces:

## ■ Memory

- The memory space includes system main memory and PCIe I/O devices
- Certain ranges of memory addresses map into I/O devices

## ■ Configuration

- This address space enables the TL to read/write configuration registers associated with I/O devices

## ■ I/O

- This address space is used for legacy PCI devices, with reserved address ranges used to address legacy I/O devices

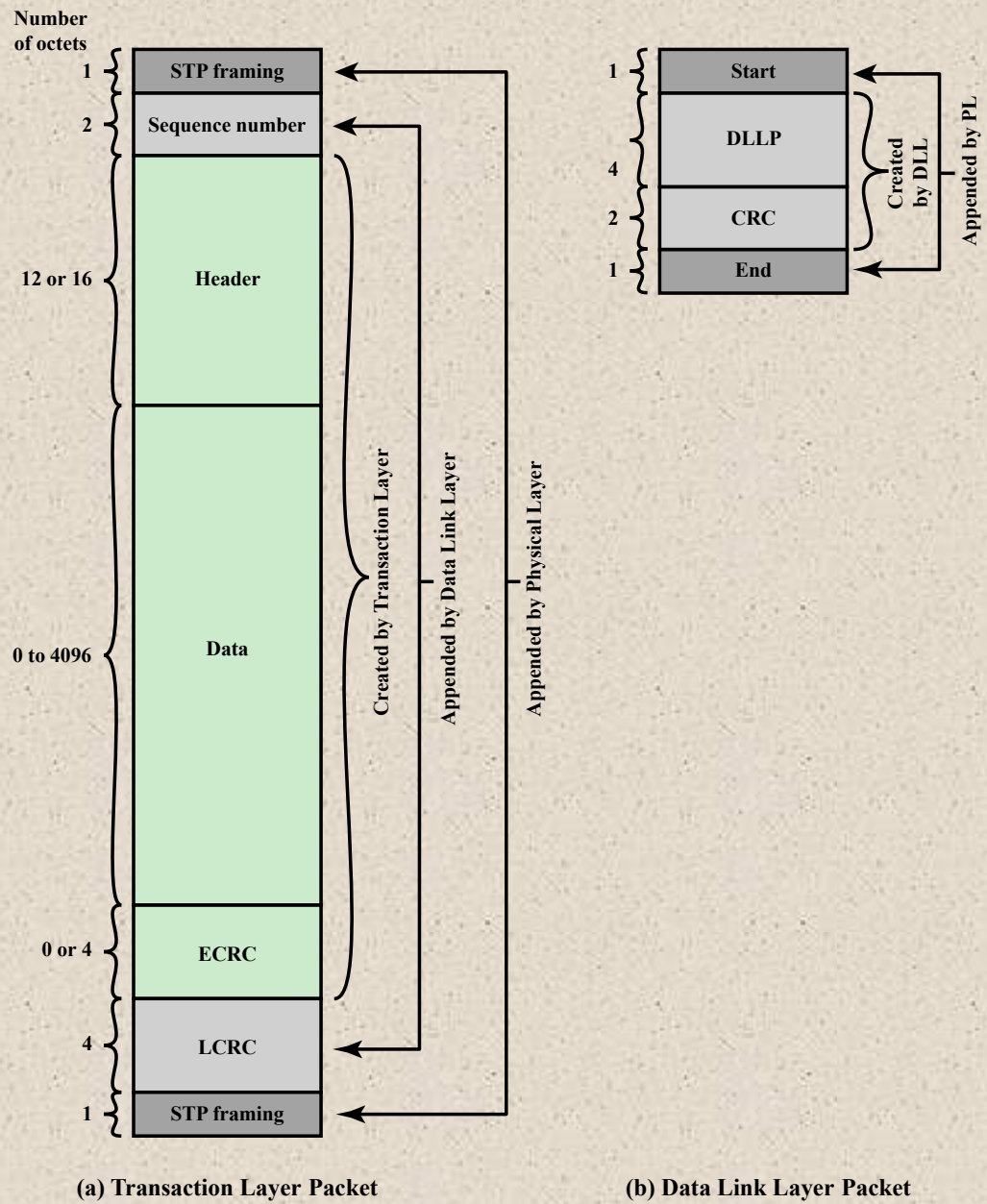
## ■ Message

- This address space is for control signals related to interrupts, error handling, and power management

# Table 3.2

## PCIe TLP Transaction Types

Address Space	TLP Type	Purpose
Memory	Memory Read Request	Transfer data to or from a location in the system memory map.
	Memory Read Lock Request	
	Memory Write Request	
I/O	I/O Read Request	Transfer data to or from a location in the system memory map for legacy devices.
	I/O Write Request	
Configuration	Config Type 0 Read Request	Transfer data to or from a location in the configuration space of a PCIe device.
	Config Type 0 Write Request	
	Config Type 1 Read Request	
	Config Type 1 Write Request	
Message	Message Request	Provides in-band messaging and event reporting.
	Message Request with Data	
Memory, I/O, Configuration	Completion	Returned for certain requests.
	Completion with Data	
	Completion Locked	
	Completion Locked with Data	



(a) Transaction Layer Packet

(b) Data Link Layer Packet

**Figure 3.25 PCIe Protocol Data Unit Format**

# + Summary

## Chapter 3

- Computer components
- Computer function
  - Instruction fetch and execute
  - Interrupts
  - I/O function
- Interconnection structures
- Bus interconnection

## A Top-Level View of Computer Function and Interconnection

- Point-to-point interconnect
  - QPI physical layer
  - QPI link layer
  - QPI routing layer
  - QPI protocol layer
- PCI express
  - PCI physical and logical architecture
  - PCIe physical layer
  - PCIe transaction layer
  - PCIe data link layer