

AUTOMOTIVE TECHNOLOGY

(BASICS)

SALES CONSULTANTS TRAINING

MILE

Mahindra Institute of Learning Excellence



SALES CONSULTANTS TRAINING

PURPOSE : *TO TRAIN DEALER SALES CONSULTANTS ON THE BASICS OF AUTOMOTIVE TECHNOLOGY*

GOAL : *AFTER THE TRAINING, A SALES CONSULTANT SHOULD BE ABLE TO READ, UNDERSTAND AND EXPLAIN ALL THE SPECIFICATIONS/TERMINOLOGIES AS GIVEN IN SALES LEAFLETS & SALES KITS*

ANATOMY OF AN AUTOMOBILE

(REAR WHEEL DRIVE - 2WD)

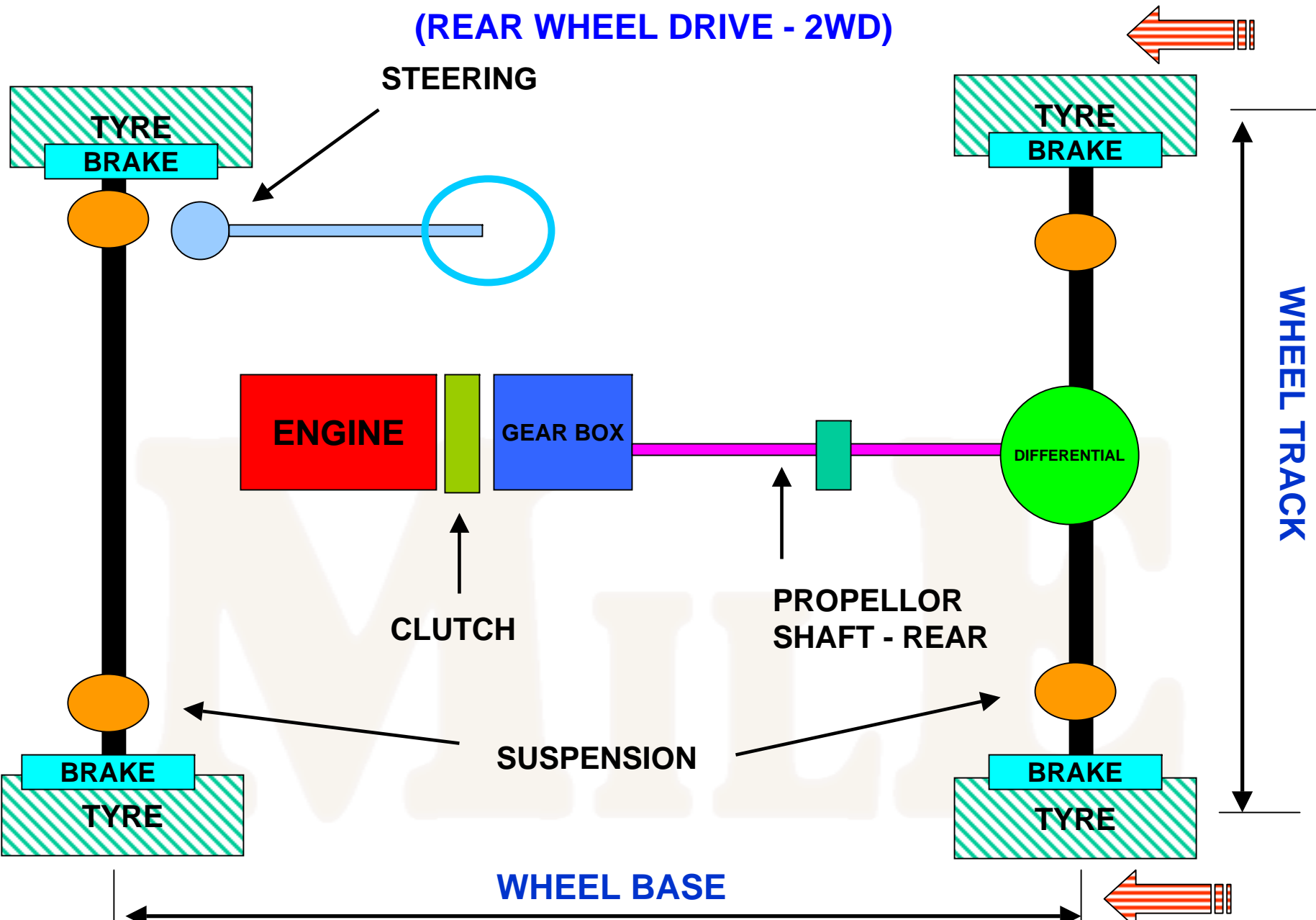

ANATOMY OF AN AUTOMOBILE (FOUR WHEEL DRIVE)

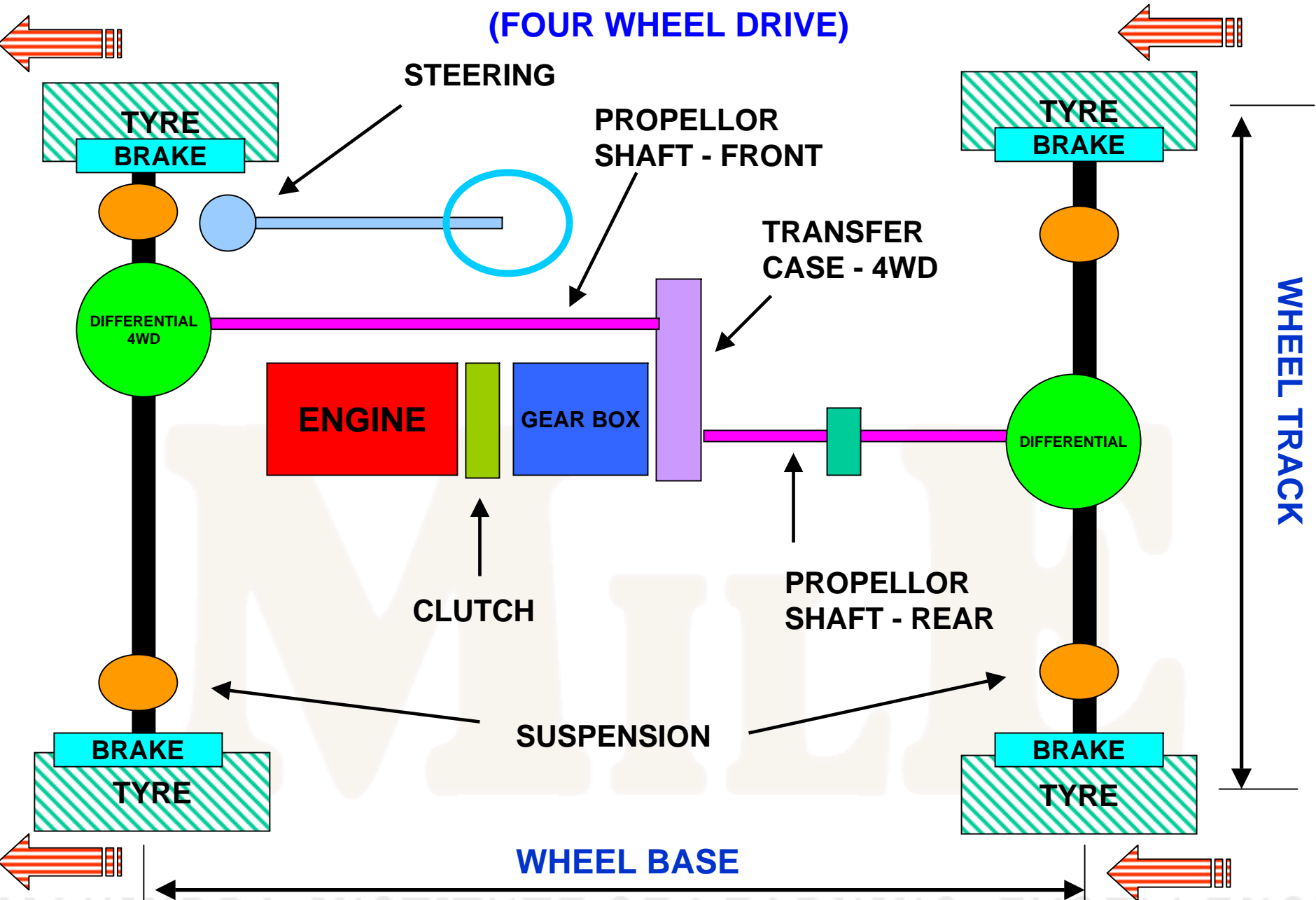

ANATOMY OF AN AUTOMOBILE (FRONT WHEEL DRIVE)

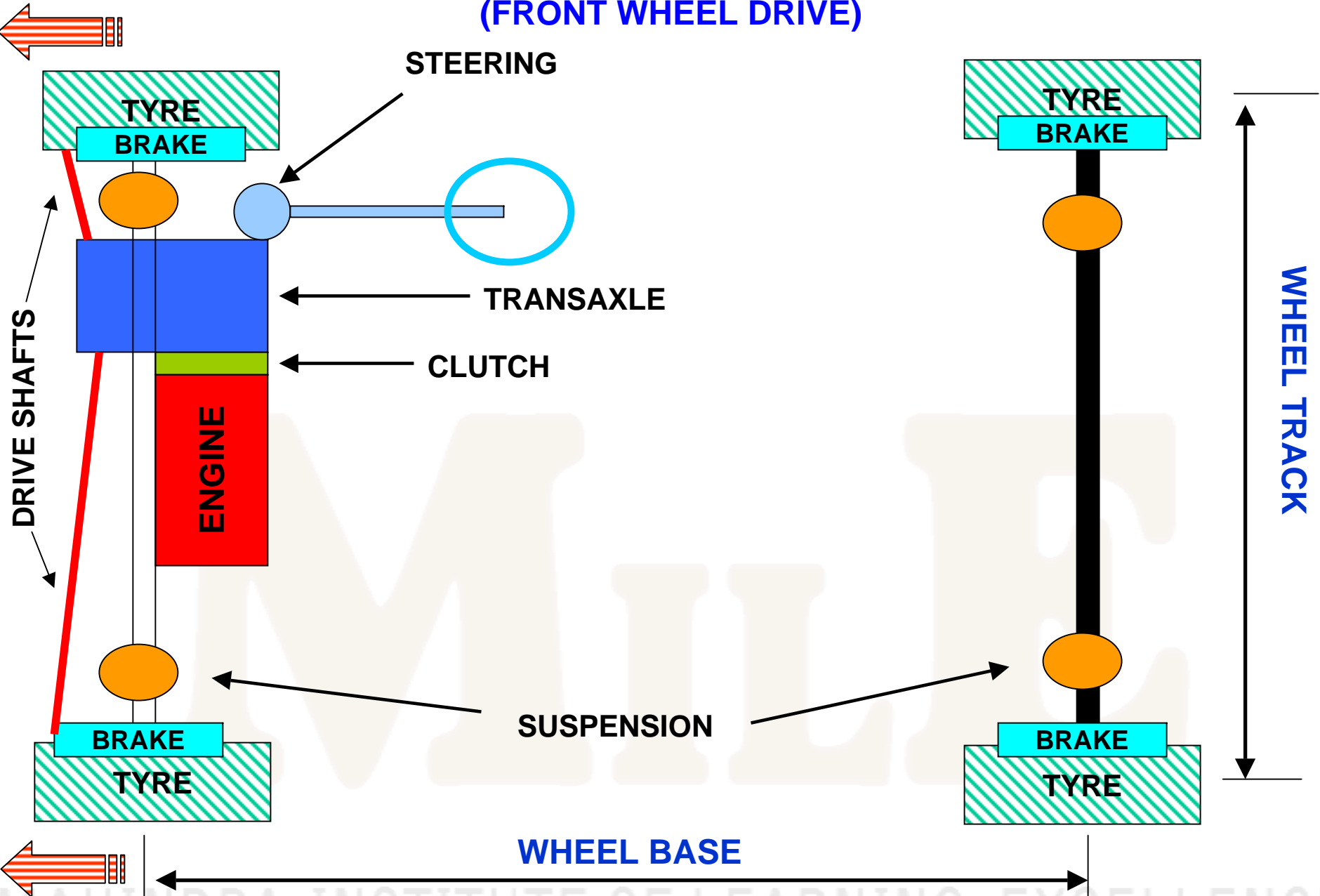

SYSTEMS IN AN AUTOMOBILE

A. POWER TRAIN SYSTEM

- **POWER PLANT (POWER GENERATION - ENGINE)**

- **ENGINE**
- **FUEL SYSTEM**
- **INTAKE SYSTEM**
- **EXHAUST SYSTEM**
- **COOLING SYSTEM**

- **DRIVE LINE (POWER TRANSMISSION)**

- **CLUTCH**
- **GEAR BOX/TRANSMISSION**
- **TRANSFER CASE**
- **DIFFERENTIAL**
- **WHEELS/TYRES**

B. RUNNING SYSTEM

- **SUSPENSION**
- **STEERING**
- **BRAKING**

C. COMFORT SYSTEM

- **HVAC/AC/HEATER SYSTEM**
- **SEATING/UPHOLSTRY/FACIA/INSTRUMENTS**
- **AUDIO/VIDEO/GPS**

ANATOMY OF AN AUTOMOBILE - POWER PLANT

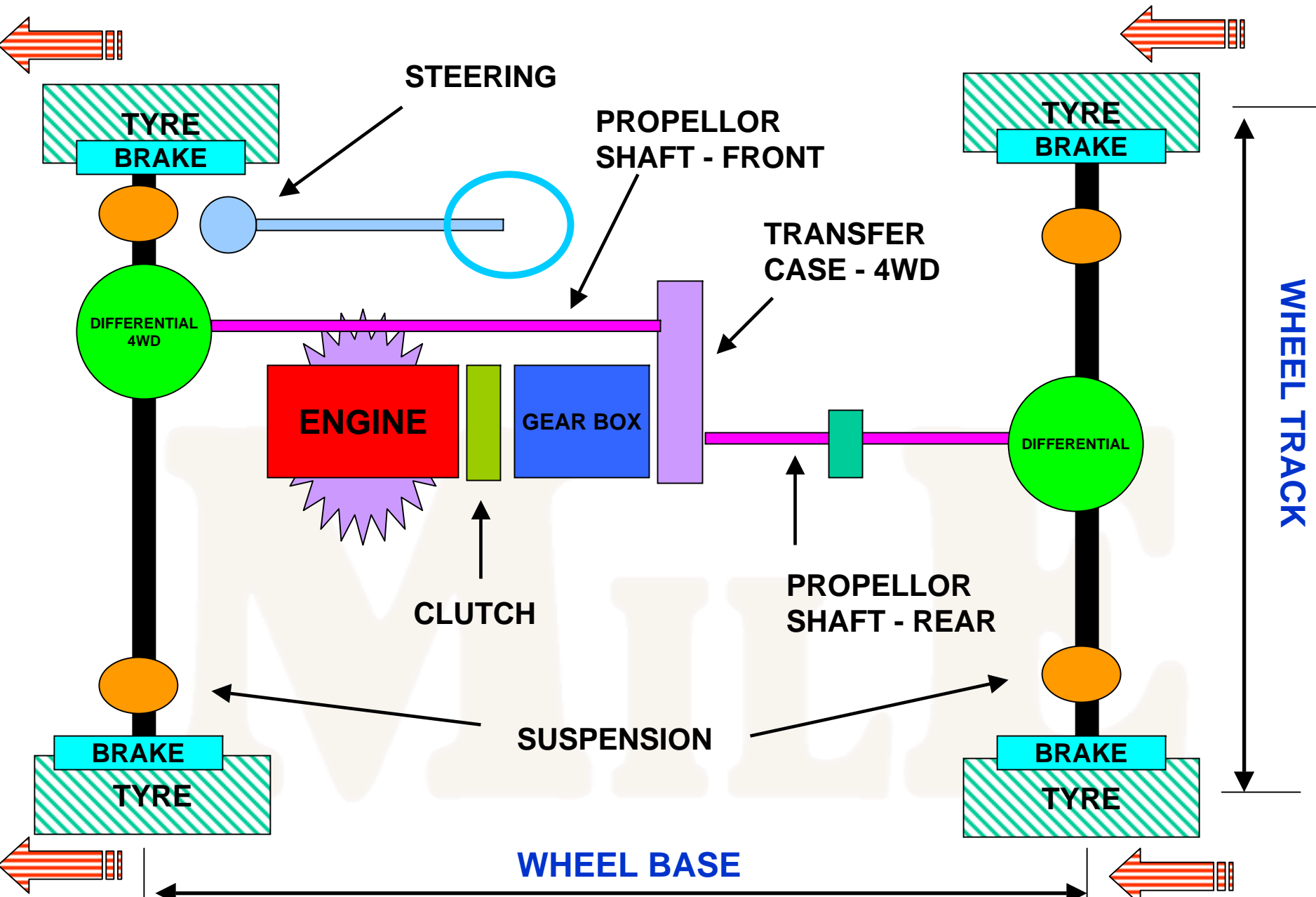

ENGINE

ENGINE IS THE HEART OF THE AUTOMOBILE

- IT GENERATES MOTIVE POWER FOR LOCOMOTION
- IT CONVERTS **CHEMICAL ENERGY** OF THE FUEL TO **MECHANICAL ENERGY**
- ENGINE DEVELOPS POWER & TORQUE

TORQUE : - Is the capacity to do work
Measured in **Kg-m , N-m , Lb-ft**

POWER : - How fast the work can be done
Measured in - **Horse Power, Kilo watt**

SYSTEMS IN AN AUTOMOBILE

A. POWER TRAIN SYSTEM

- **POWER PLANT (POWER GENERATION - ENGINE)**

- **ENGINE** 
- **FUEL SYSTEM**
- **INTAKE SYSTEM**
- **EXHAUST SYSTEM**
- **COOLING SYSTEM**

- **DRIVE LINE (POWER TRANSMISSION)**

- **CLUTCH**
- **GEAR BOX/TRANSMISSION**
- **TRANSFER CASE**
- **DIFFERENTIAL**
- **WHEELS/TYRES**

B. RUNNING SYSTEM

- **SUSPENSION**
- **STEERING**
- **BRAKING**

C. COMFORT SYSTEM

- **HVAC/AC/HEATER SYSTEM**
- **SEATING/UPHOLSTRY/FACIA/INSTRUMENTS**
- **AUDIO/VIDEO/GPS**

ENGINE OPERATION - 4 STROKE

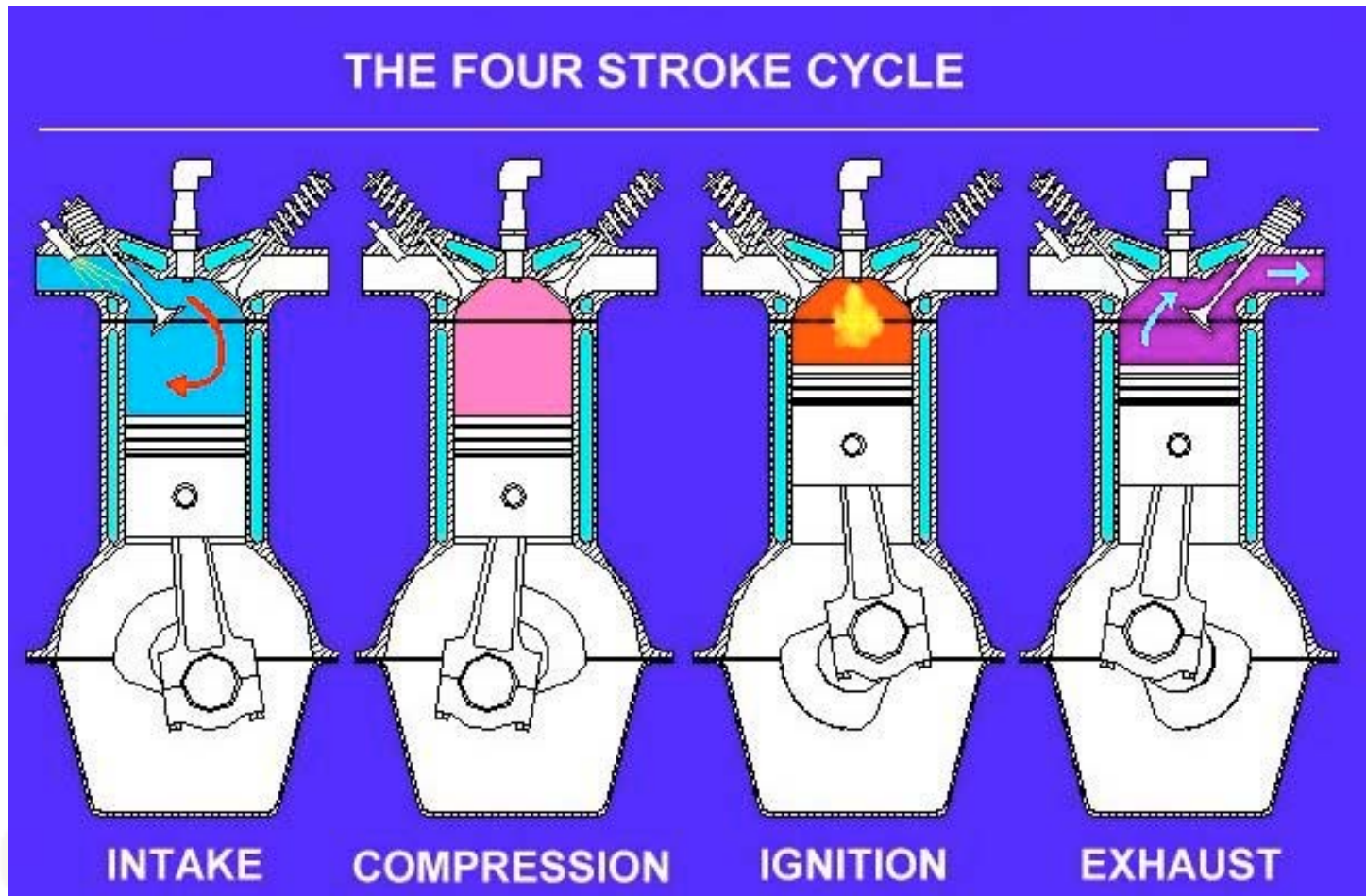

CLASSIFICATION OF ENGINES

ENGINES CAN BE CLASSIFIED IN MANY WAYS :

- 1. By Mechanical construction - 4 Stroke/2-Stroke**
- 2. By type of Ignition - Compression Ignition/Spark Ignition**

COMPRESSION IGNITION ENGINES

- Basically **Diesel engines**
- Use diesel fuel
- Combustion is initiated by heat, on its own

SPARK IGNITION ENGINES

- Basically **Petrol engines, LPG engines, CNG engines**
- Use leaded or unleaded petrol, Alcohol, LPG or CNG
- Combustion is initiated by a spark from a spark plug

DIESEL ENGINE

DIESEL ENGINES ARE COMPRESSION IGNITION ENGINES & USE DIESEL FUEL

DIESEL ENGINES ARE BROADLY CLASSIFIED AS **DIRECT INJECTION (DI)** AND **INDIRECT INJECTION (IDI)**

DIRECT INJECTION ENGINE (DI)

ON DIRECT INJECTION DIESEL ENGINES, FUEL IS SPRAYED DIRECTLY ON TOP OF THE PISTON.

- **Highly fuel efficient**
- **Noisy**
- **Easy cold starting ability**

INDIRECT INJECTION ENGINE

ON INDIRECT INJECTION DIESEL ENGINES, FUEL IS SPRAYED ON TO A SEPERATE PRE-CHAMBER.

- **Less fuel efficient**
- **Less Noisy/smoothen**
- **Requires pre-heating for starting**

PETROL/CNG/LPG ENGINES

PETROL ENGINES ARE SPARK IGNITION ENGINES & USE GASOLINE/CNG/LPG FUEL

PETROL ENGINES ARE BROADLY CLASSIFIED AS **CARBURATED** AND **FUEL INJECTED ENGINE**

CARBURETED ENGINE

ON CARBURETED ENGINE , THE PETROL & AIR ARE MIXED IN THE CARBURETER BEFORE BEING SENT IN TO THE ENGINE

FUEL INJECTED ENGINE

ON FUEL INJECTED ENGINES, THE PETROL IS INJECTED SEPERATELY AND THE PETROL AND AIR ARE MIXED INSIDE THE CYLINDER.

FUEL INJECTED ENGINES CAN BE FURTHER CLASSIFIED AS :

SINGLE/MULTI POINT FUEL INJECTION, Where the fuel is injected outside the cylinder

GASOLINE DIRECT INJECTION (GDI) , Where the fuel is injected directly in to the engine cylinder

INTERNAL COMBUSTION ENGINE

RECIPROCATING

ROTARY

GAS TURBINE

4STROKE

2STROKE

COMPRESSION IGNITION

(DIESEL)

SPARK IGNITION

(GASOLINE/LPG/CNG)

INDIRECT INJECTION

- **XD3P**
- **XDP 4.90**
- **SD 25**

DIRECT INJECTION

- **MDI 3200**
- **SZ 2600 (SCORPIO)**
- **NEF NA (LOADKING)**
- **SIMPSON S4**
- **GREAVES**

CARBURETED

- **F4-134**
- **P 2150**
- **P2150 CNG**

SINGLE POINT INJECTION

MULTI POINT INJECTION

- **RENAULT F4R**
- **ISUZU**

THERMAL EFFICIENCY

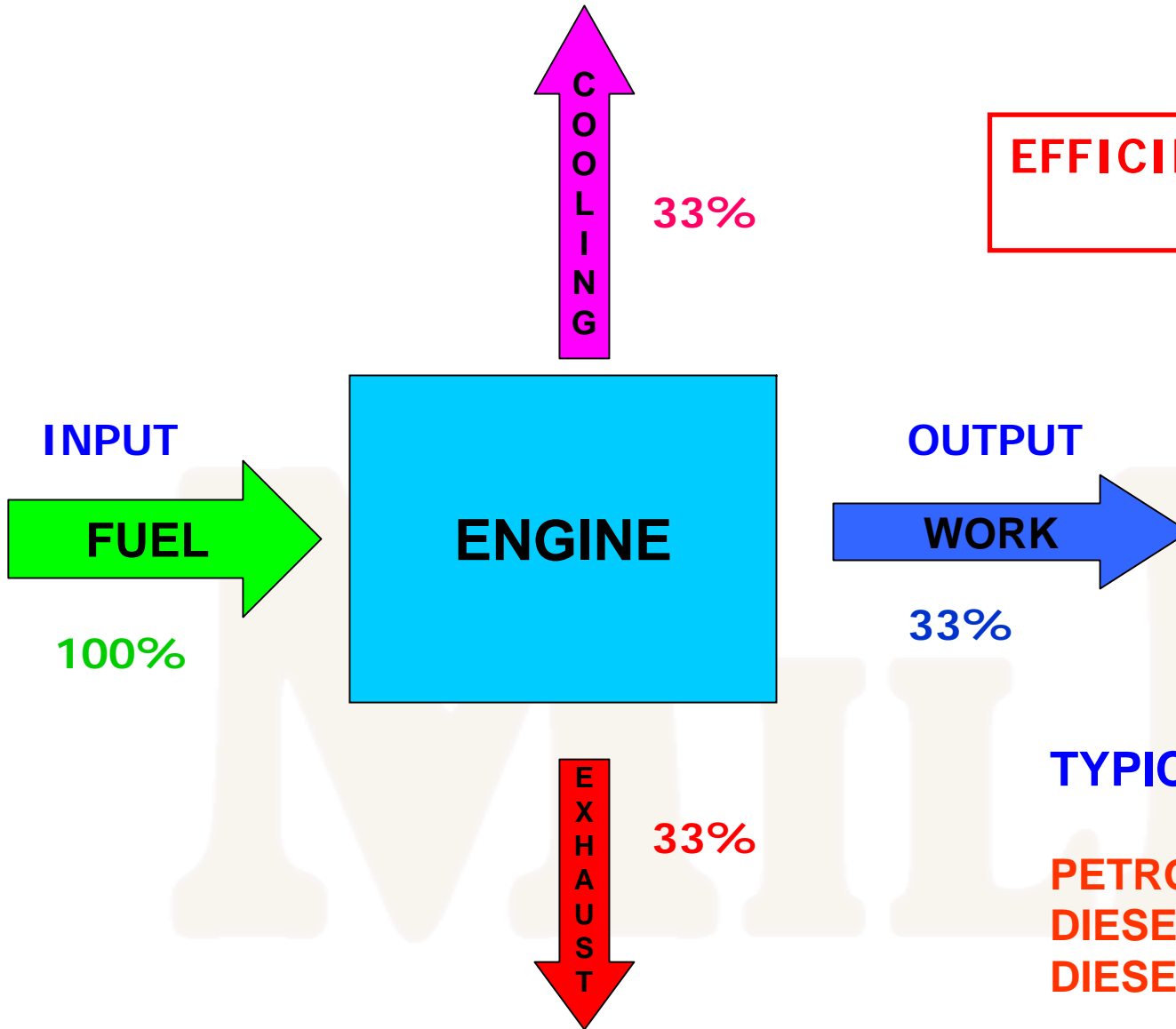

$$\text{EFFICIENCY} = \frac{\text{OUTPUT}}{\text{INPUT}} \%$$

TYPICAL EFFICIENCIES

- PETROL - 25%
- DIESEL IDI - 28-30%
- DIESEL DI - 32-33%

FUEL EFFICIENCY

(FUEL CONSUMPTION)

**FUEL EFFICIENCY IS A COMBINATION OF ENGINE EFFICIENCY,
VEHICLE PARAMETERS & DRIVING PATTERN**

ENGINE EFFICIENCY

+

TRANSMISSION EFFICIENCY

(CLUTCH+GEARBOX+DIFFERENTIAL+ WHEELS + TYRES)

+

WEIGHT/LOAD/SPEED

+

AERODYNAMIC PARAMETERS

(DRAG - BODY SHAPE)

+

DRIVING PATTERN

(DRIVING STYLE & TRAFFIC CONDITIONS)

FUEL EFFICIENCY - Kms/Lit OR Lit/100 Kms

ENGINE PARAMETERS

CLEARANCE VOLUME

THE FOUR STROKE CYCLE

STROKE, mm

BORE, mm

CYLINDER CAPACITY, cc

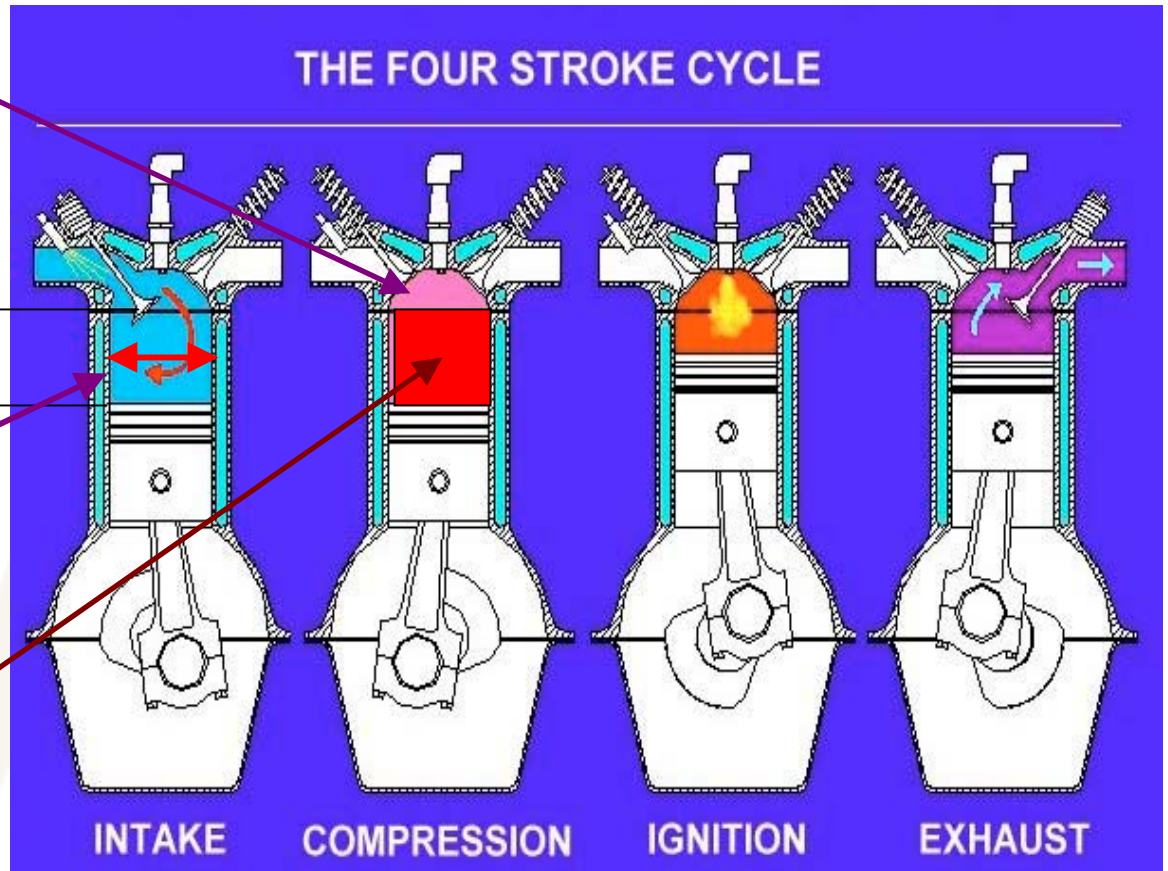

ENGINE CAPACITY, cc = CYL. CAPACITY X No OF CYL

UNITS - cc - Cubic centimeter

- Lit - Liters = cc/1000

ENGINE PARAMETERS

BORE, mm : The diameter of the cylinder

STROKE, mm : The distance between top most point of piston travel to the bottommost point of piston movement

CAPACITY, cc : Also called displacement. The volume displaced by all pistons while moving from top to bottom. Also indicated in Liters.

CLEARANCE VOLUME : The volume available above piston, with the piston in top most point.

COMPRESSION RATIO : The ratio between the total volume to the clearance volume.

VALVE MECHANISM : The mechanism by which the valves are operated. It could be **push rod type or overhead camshaft type**

TIMING SYSTEM : The mechanism by which the camshaft & fuel injection pump are operated . It could be **gear driven, chain driven or belt driven.**

VALVE OPERATING MECHANISM

(NO. OF VALVES PER CYLINDER)

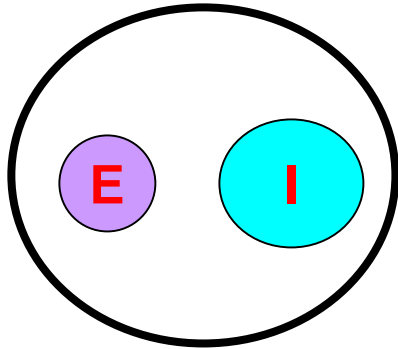

2 VALVES/CYL

- ALL M&M MODELS

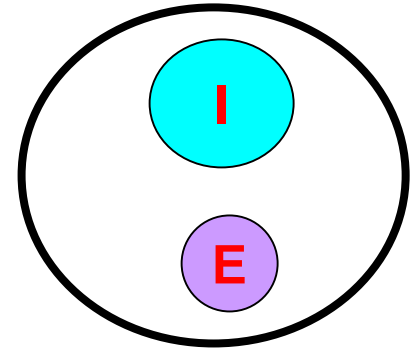

2 VALVES/CYL

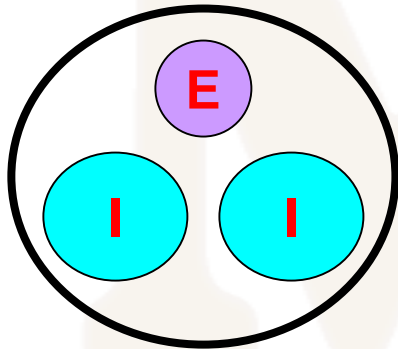

3 VALVES/CYL

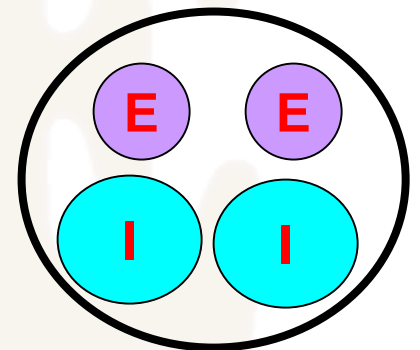

4 VALVES/CYL

- SCORPIO PETROL

VALVE OPERATING MECHANISM

(CAMSHAFT LOCATIONS)

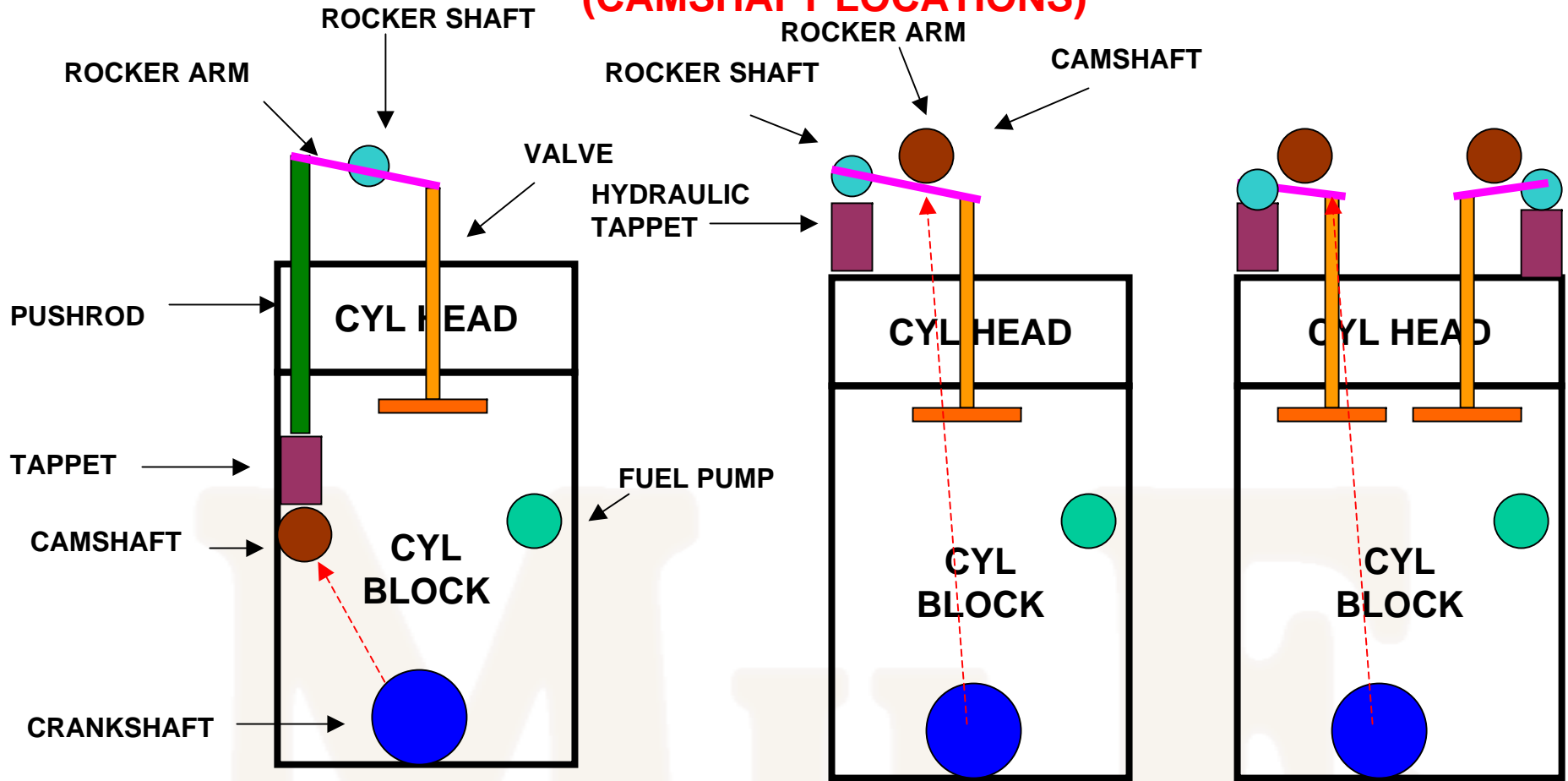

PUSH ROD ENGINE

- XD3P
- XDP4.90
- SZ 2600
- MDI 3200
- SIMPSON S4
- GREAVES

SOHC

DOHC

- RENAULT F4R

OVERHEAD CAM ENGINE

VALVE OPERATING MECHANISM

SINGLE OVERHEAD CAMSHAFT (SOHC)

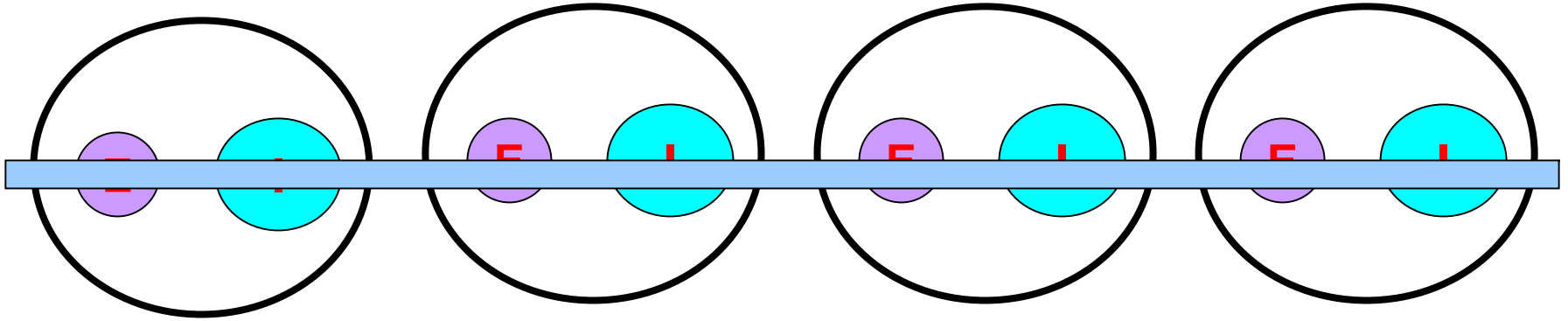

2 VALVES/CYL , SOHC - VALVES OPERATED EITHER **DIRECTLY** OR THROUGH **ROCKERS**

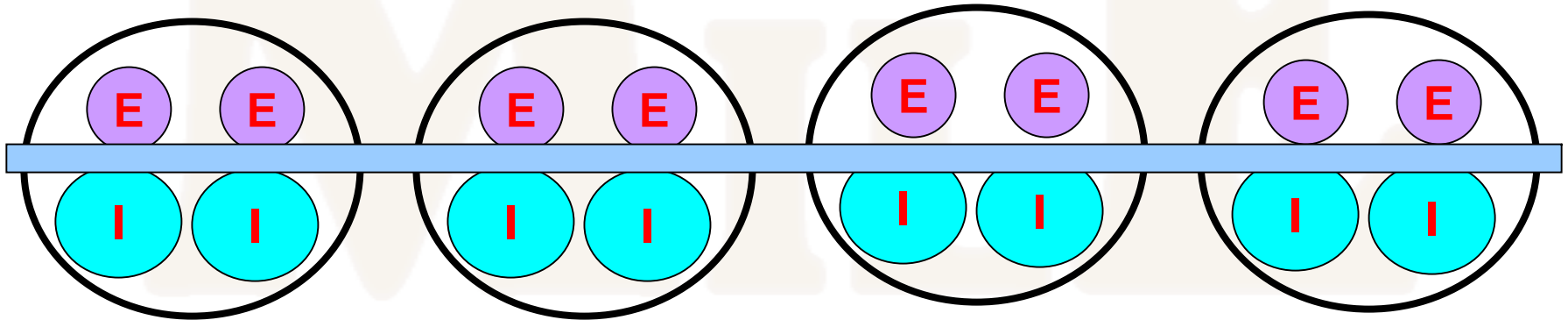

4 VALVES/CYL , SOHC - VALVES OPERATED THROUGH **ROCKERS**

VALVE OPERATING MECHANISM

DOUBLE OVERHEAD CAMSHAFT (DOHC)

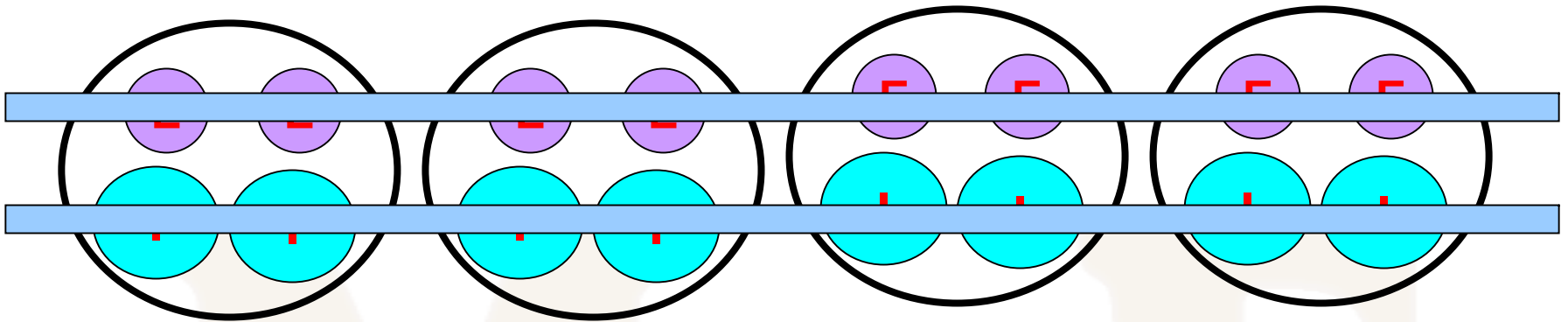

4 VALVES/CYL , DOHC - VALVES OPERATED EITHER **DIRECTLY** OR THROUGH **ROCKERS**

GEAR DRIVE ENGINE

- XDP4.90
- SZ 2600

TIMING MECHANISM

GEAR DRIVE ENGINE

- MDI 3200

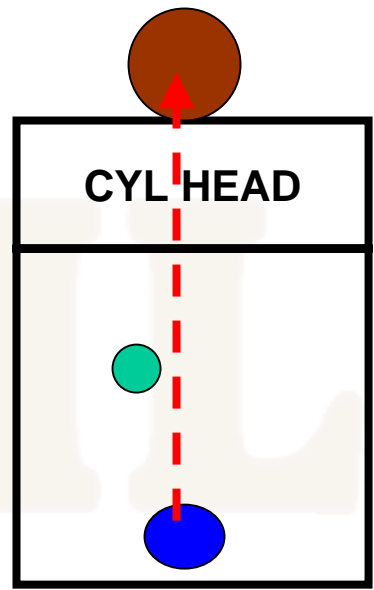
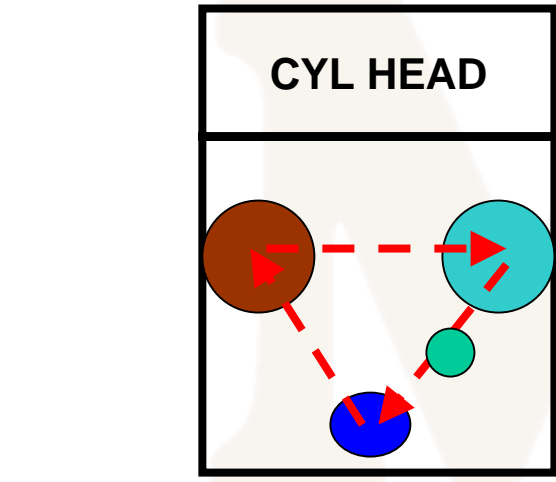
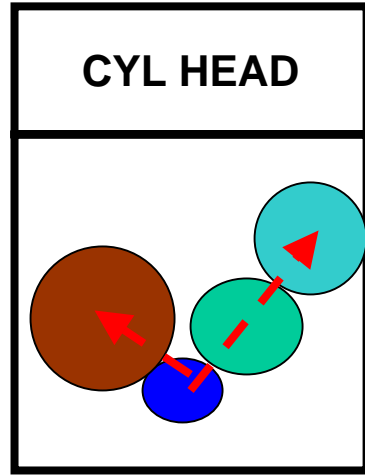
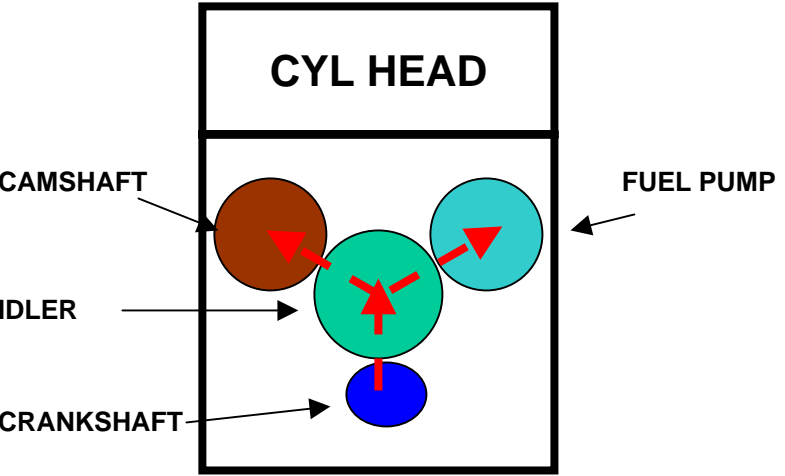

CHAIN DRIVE ENGINE

- XD 3P
- SZ 2600

BELT DRIVE ENGINE

- RENAULT F4R

ENGINE SUPPORT SYSTEMS

FOR THE ENGINE TO FUNCTION, IT REQUIRES SUPPORT SYSTEMS.
THE MAJOR SUPPORT SYSTEMS OF AN ENGINE ARE :

FUEL SYSTEM

INTAKE SYSTEM

EXHAUST SYSTEM

COOLING SYSTEM

SYSTEMS IN AN AUTOMOBILE

A. POWER TRAIN SYSTEM

- POWER PLANT (POWER GENERATION - ENGINE)

- ENGINE
- FUEL SYSTEM
- INTAKE SYSTEM
- EXHAUST SYSTEM
- COOLING SYSTEM



- DRIVE LINE (POWER TRANSMISSION)

- CLUTCH
- GEAR BOX/TRANSMISSION
- TRANSFER CASE
- DIFFERENTIAL
- WHEELS/TYRES

B. RUNNING SYSTEM

- SUSPENSION
- STEERING
- BRAKING

C. COMFORT SYSTEM

- HVAC/AC/HEATER SYSTEM
- SEATING/UPHOLSTRY/FACIA/INSTRUMENTS
- AUDIO/VIDEO/GPS

ENGINE SUPPORT SYSTEMS

FUEL SYSTEM

- FUEL SYSTEM IS THE HEART OF THE ENGINE
- IT TRANSPORTS FUEL FROM THE FUEL TANK AND INJECTS IT UNDER HIGH PRESSURE INTO THE ENGINE
- FUEL INJECTION SYSTEM IS A HIGH PRECISION, HIGH TECHNOLOGY PRODUCT
- FUEL INJECTION PUMPS ARE OF 2 TYPES - **INLINE PUMP & ROTARY PUMP**
- IN INDIA, **MICO & DELPHI-TVS** MANUFACTURES FUEL INJECTION SYSTEM
- COMPONENTS OF FUEL SYSTEM ARE :
 - **FUEL INJECTION PUMP(FIP)**
 - **FUEL TRANSFER PUMP**
 - **FUEL INJECTORS**
 - **FUEL FILTERS**
 - **FUEL LINES**

FUEL SYSTEM

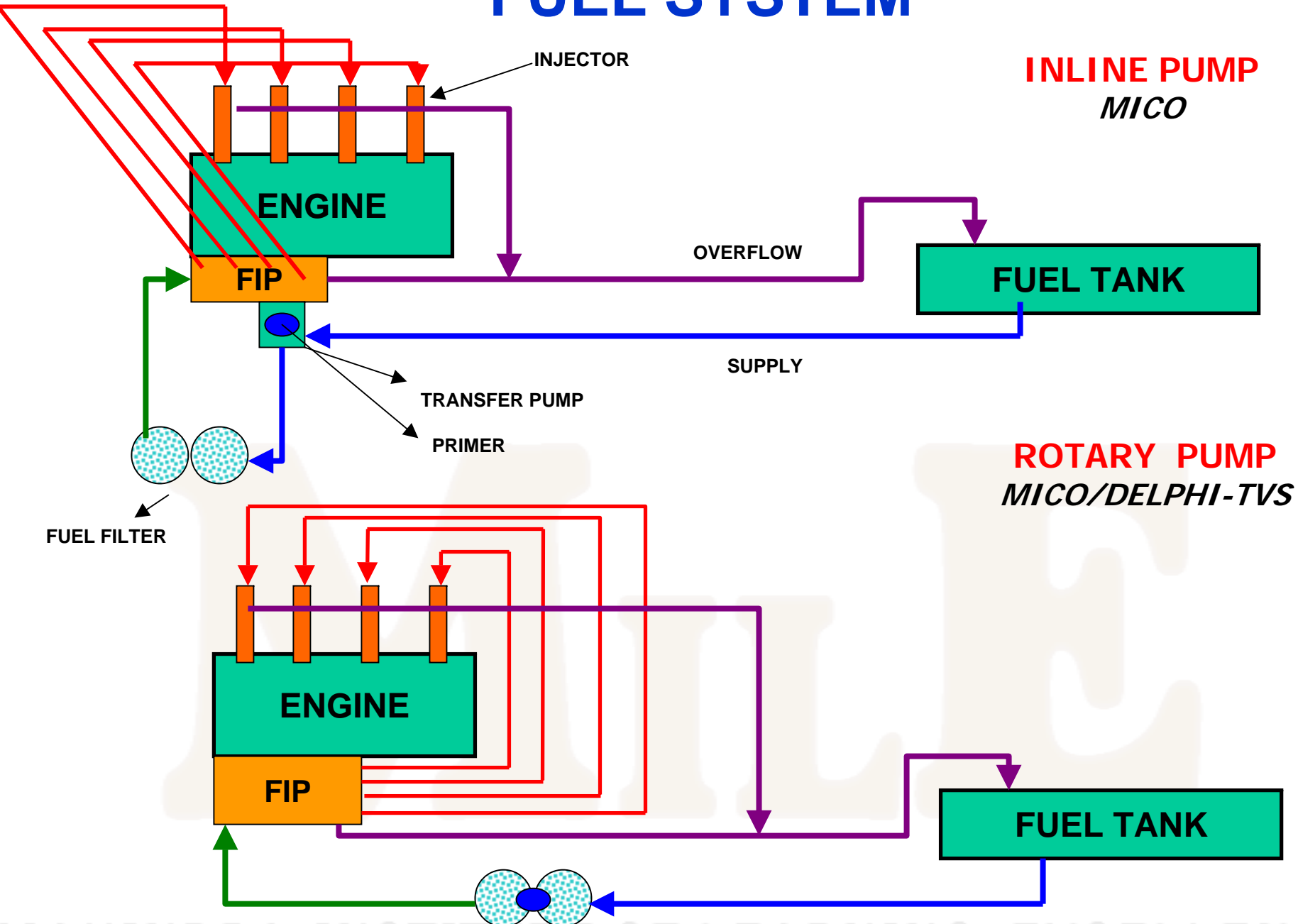

INLINE PUMP
MICO

INJECTOR

ENGINE

FIP

OVERFLOW

FUEL TANK

SUPPLY

TRANSFER PUMP

PRIMER

ROTARY PUMP
MICO/DELPHI-TVS

FUEL FILTER

ENGINE

FIP

FUEL TANK

FUEL SYSTEM COMPONENTS

1. FUEL INJECTION PUMP - Fuel injection pump sucks fuel from the tank , pressurises the fuel to approx. 600 - 1000 bar and sends it to the injectors.

- **Inline FIP** - Has separate pumping chambers for each cylinder

- **Rotary FIP(Distributor pump)** - Has one pumping chamber and the pump distributes to each cylinder as per sequence- firing order

2. INJECTORS - Inject the high pressure fuel in to each cylinder.

3. FUEL FILTER - Filters the fuel from dirt & sediments, since the Fuel injection pump requires clean fuel.

SYSTEMS IN AN AUTOMOBILE

A. POWER TRAIN SYSTEM

- **POWER PLANT (POWER GENERATION - ENGINE)**

- **ENGINE**
- **FUEL SYSTEM**
- **INTAKE SYSTEM**
- **EXHAUST SYSTEM**
- **COOLING SYSTEM**



- **DRIVE LINE (POWER TRANSMISSION)**

- **CLUTCH**
- **GEAR BOX/TRANSMISSION**
- **TRANSFER CASE**
- **DIFFERENTIAL**
- **WHEELS/TYRES**

B. RUNNING SYSTEM

- **SUSPENSION**
- **STEERING**
- **BRAKING**

C. COMFORT SYSTEM

- **HVAC/AC/HEATER SYSTEM**
- **SEATING/UPHOLSTRY/FACIA/INSTRUMENTS**
- **AUDIO/VIDEO/GPS**

ENGINE SUPPORT SYSTEMS

INTAKE SYSTEM

INTAKE SYSTEM **CLEANS & TRANSPORTS** ATMOSPHERIC AIR TO THE ENGINE CYLINDERS

NA ENGINE - NATURALLY ASPIRATED ENGINE - The air is transported to the engine cylinder , at atmospheric pressure

TURBO ENGINE - TURBO CHARGED ENGINE - The air is compressed and transported to engine cylinder, at higher than atmospheric pressure.

COMPONENTS OF THE INTAKE SYSTEM

- AIR FILTER
- TURBO CHARGER
- INTERCOOLER
- AIR FILTER CLOGGING INDICATOR
- HOSES

INTAKE SYSTEM

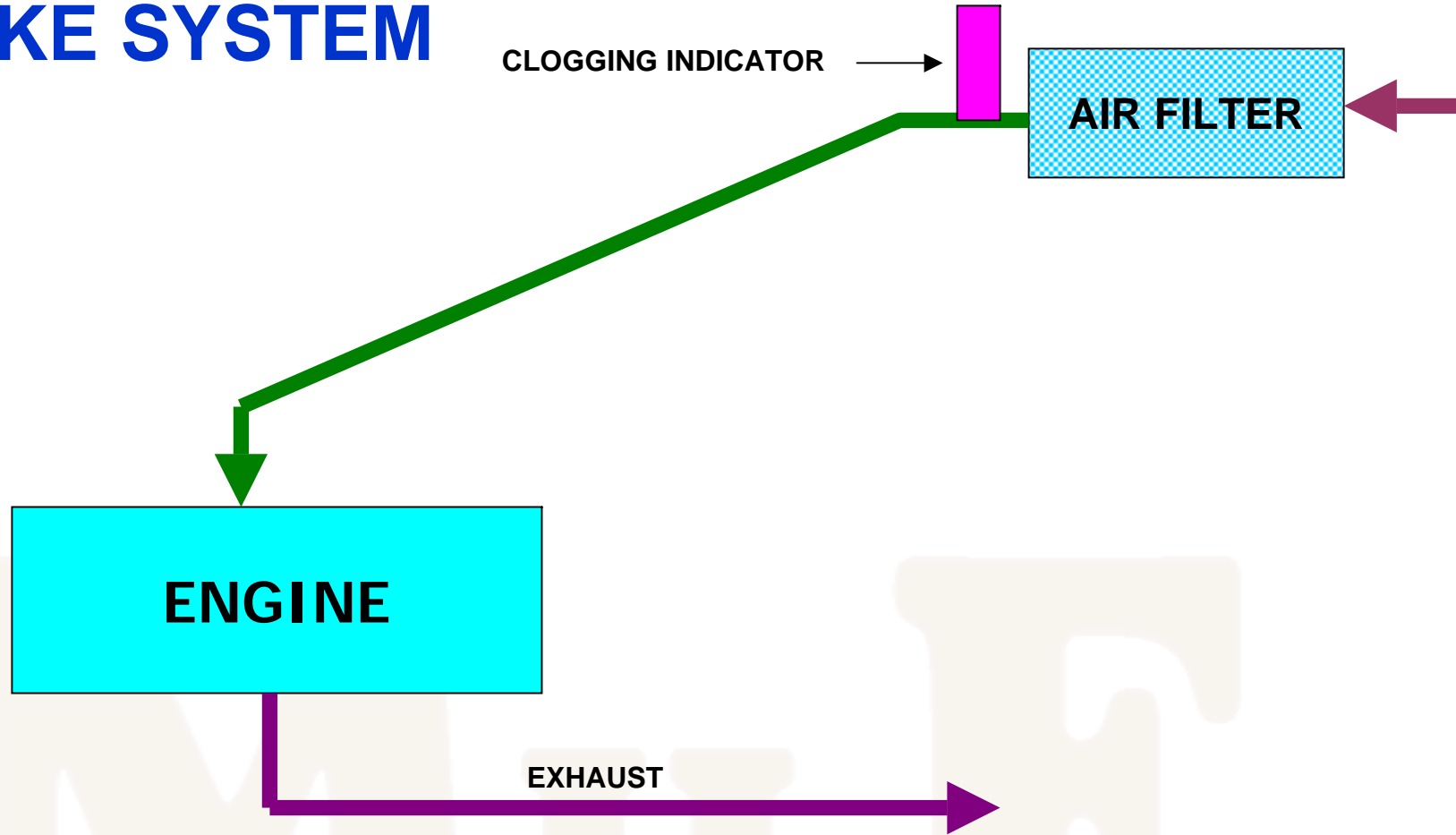

NATURALLY ASPIRATED ENGINE

- MDI 3200
- XDP 490
- XD 3P

INTAKE SYSTEM

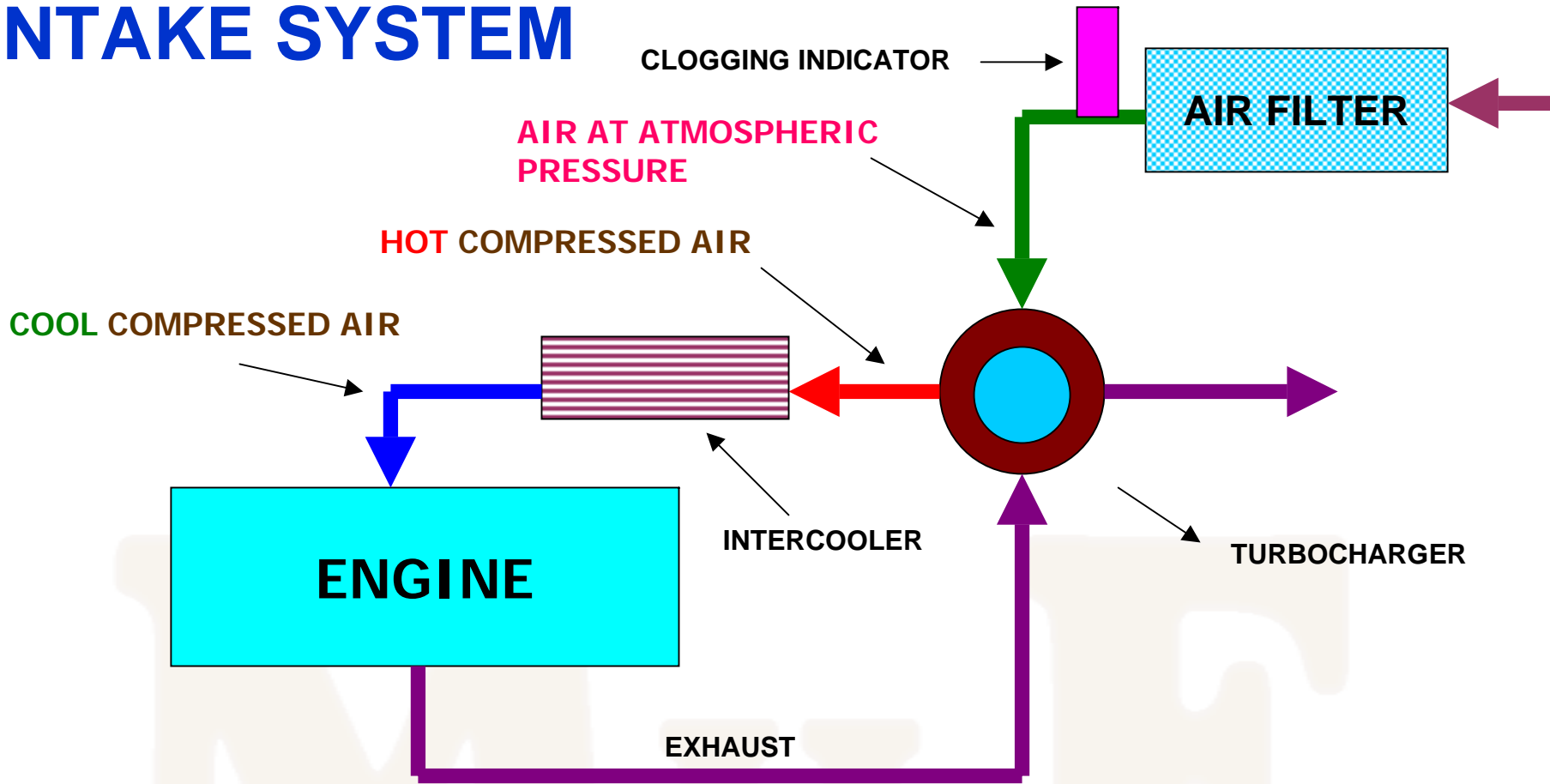

TURBO CHARGED/INTERCOOLED ENGINE

• SZ 2600

INTAKE SYSTEM

1. AIR FILTER - The purpose of the air filter is to clean the atmospheric air of dirt & dust before entering the engine cylinder. Air filters need to be cleaned regularly and replaced at recommended intervals.

2. CLOGGING INDICATOR - Clogging indicator indicates the condition of the air filter as to whether it is clean or choked.

A visible RED band in the indicator indicates a choked air filter

MILE

INTAKE SYSTEM

3. TURBOCHARGER - The turbo charger utilizes the wasted heat energy in the exhaust system, to run a compressor which compresses the intake air. Compressed intake air has more density and hence more fuel can be injected increasing the power of the engine.

Turbo charging is an ideal way to increase the engine power without increasing the engine size.

For trouble free performance of turbocharger a clean air filter element is a must.

A turbo charger spins at very high speed (~ 1.6 Lakh RPM). The turbo charger is lubricated by engine oil. If the engine is switched off abruptly , the oil supply to turbo bearing stops instantly. Since the turbine is running at very high speeds, it takes some time to wind down. During this time the turbine bearing can be starved off oil.

Hence it is recommended to idle the engine for some time before shutting off the engine.

INTAKE SYSTEM

4. INTERCOOLER - When the atmospheric air is compressed by the compressor in the turbocharger, the temperature of the air increases. The temperature of the air needs to be reduced before it enters the engine cylinder. The hot compressed air is passed through a **intercooler** to reduce the temperature.

Intercooler is a heat exchanger where the hot **compressed air** flows on the inside and **cool atmospheric air** flows on the outside leading to cooling of the compressed air

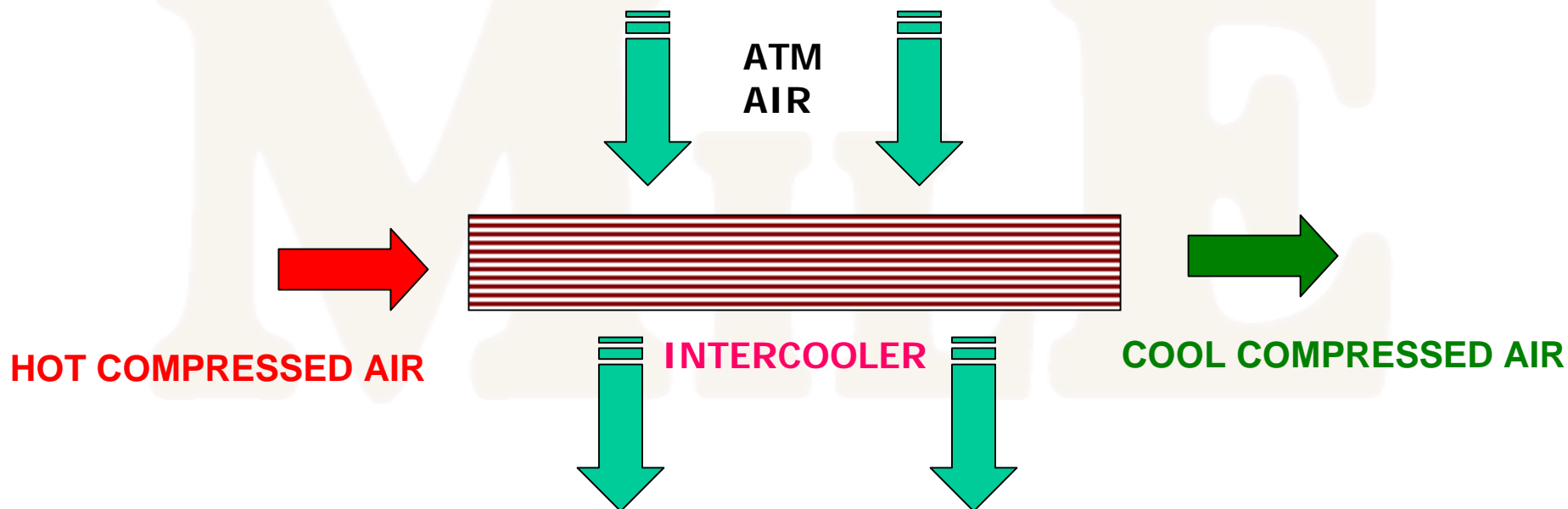

SYSTEMS IN AN AUTOMOBILE

A. POWER TRAIN SYSTEM

- **POWER PLANT (POWER GENERATION - ENGINE)**

- **ENGINE**
- **FUEL SYSTEM**
- **INTAKE SYSTEM**
- **EXHAUST SYSTEM**
- **COOLING SYSTEM**



- **DRIVE LINE (POWER TRANSMISSION)**

- **CLUTCH**
- **GEAR BOX/TRANSMISSION**
- **TRANSFER CASE**
- **DIFFERENTIAL**
- **WHEELS/TYRES**

B. RUNNING SYSTEM

- **SUSPENSION**
- **STEERING**
- **BRAKING**

C. COMFORT SYSTEM

- **HVAC/AC/HEATER SYSTEM**
- **SEATING/UPHOLSTRY/FACIA/INSTRUMENTS**
- **AUDIO/VIDEO/GPS**

ENGINE SUPPORT SYSTEMS

EXHAUST SYSTEM

EXHAUST SYSTEM TRANSPORTS THE BURNED EXHAUST GASES FROM ENGINE CYLINDER TO THE ATMOSPHERE, TOWARDS THE REAR OR TO THE RIGHT SIDE OF THE VEHICLE.

Since the exhaust gases are at higher pressure than atmospheric pressure, the exhaust system has to reduce the pressure of exhaust gases so that there is no noise on discharge to atmosphere.

Catalytic converter (if fitted) reduces harmful pollutants in the exhaust gases to un-harmful gases.

COMPONENTS OF EXHAUST SYSTEM

- SILENCER/MUFFLER/EXPANSION CHAMBER**
- CATALYTIC CONVERTER**
- OXYGEN SENSOR (PETROL VEHICLES)**

EXHAUST SYSTEM

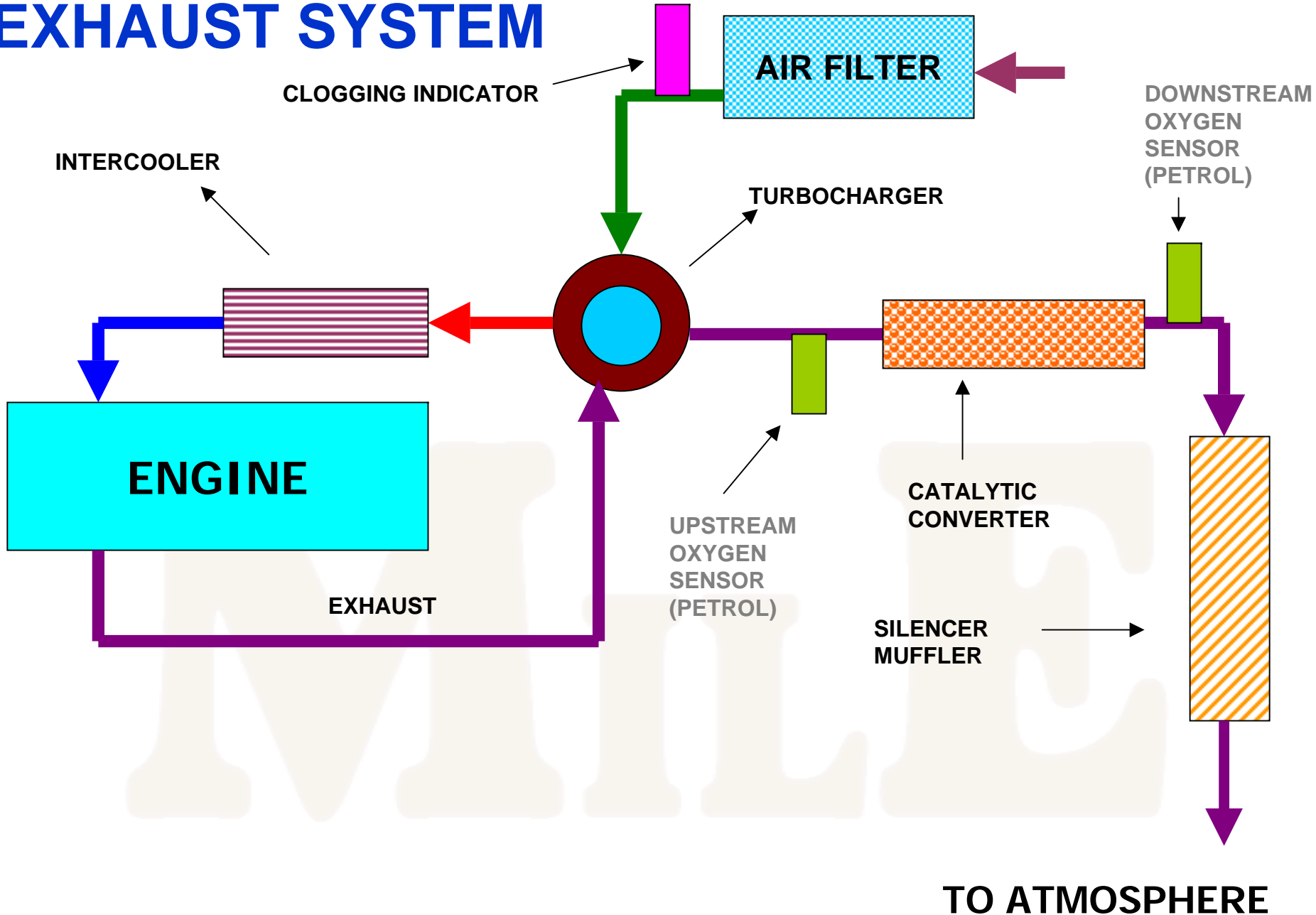

EXHAUST SYSTEM

1. SILENCER/MUFFLER/EXPANSION CHAMBER - Silencers are separate chambers fitted on the exhaust system fitted with baffles on the inside. The silencer reduces the pressure of the exhaust gases progressively and lets out the exhaust gases to atmosphere at atmospheric pressures.

2. CATALYTIC CONVERTER - Catalytic converters are emission control devices fitted on the exhaust system. Catalytic converters convert harmful exhaust gases to un-harmful gases. Catalytic converters are coated with noble metals like Platinum, Palladium, Rhodium on the inside.

Catalytic converters are of 2 types, namely :

A. OXIDATION CATALYST - Fitted on diesel engines. Converts CO, HC to CO₂ and H₂O.

B. THREE WAY CATALYST - Fitted on Petrol engines. Converts CO, HC & NO_x to CO₂, H₂O & N₂.

SYSTEMS IN AN AUTOMOBILE

A. POWER TRAIN SYSTEM

- **POWER PLANT (POWER GENERATION - ENGINE)**

- **ENGINE**
- **FUEL SYSTEM**
- **INTAKE SYSTEM**
- **EXHAUST SYSTEM**
- **COOLING SYSTEM**



- **DRIVE LINE (POWER TRANSMISSION)**

- **CLUTCH**
- **GEAR BOX/TRANSMISSION**
- **TRANSFER CASE**
- **DIFFERENTIAL**
- **WHEELS/TYRES**

B. RUNNING SYSTEM

- **SUSPENSION**
- **STEERING**
- **BRAKING**

C. COMFORT SYSTEM

- **HVAC/AC/HEATER SYSTEM**
- **SEATING/UPHOLSTRY/FACIA/INSTRUMENTS**
- **AUDIO/VIDEO/GPS**

ENGINE SUPPORT SYSTEMS

COOLING SYSTEM

COOLING SYSTEM REMOVES THE EXCESSIVE HEAT OF COMBUSTION FROM THE ENGINE.

Cooling system circulates coolant (Combination of water and a chemical) through the engine components which absorbs the heat and transfers the heat to the atmospheric air through a heat exchanger.

COMPONENTS OF THE COOLING SYSTEM

- **WATER PUMP**
- **THERMOSTAT**
- **COOLING FAN**
- **OIL COOLER**
- **RADIATOR**
- **RADIATOR PRESSURE CAP**
- **COOLANT RECOVERY TANK/DEGASSING TANK**
- **DRIVE BELTS**

COOLING SYSTEM

RADIATOR PRESSURE CAP

THERMOSTAT



RADIATOR

COOLING FAN

WATER PUMP

OIL COOLER

ENGINE

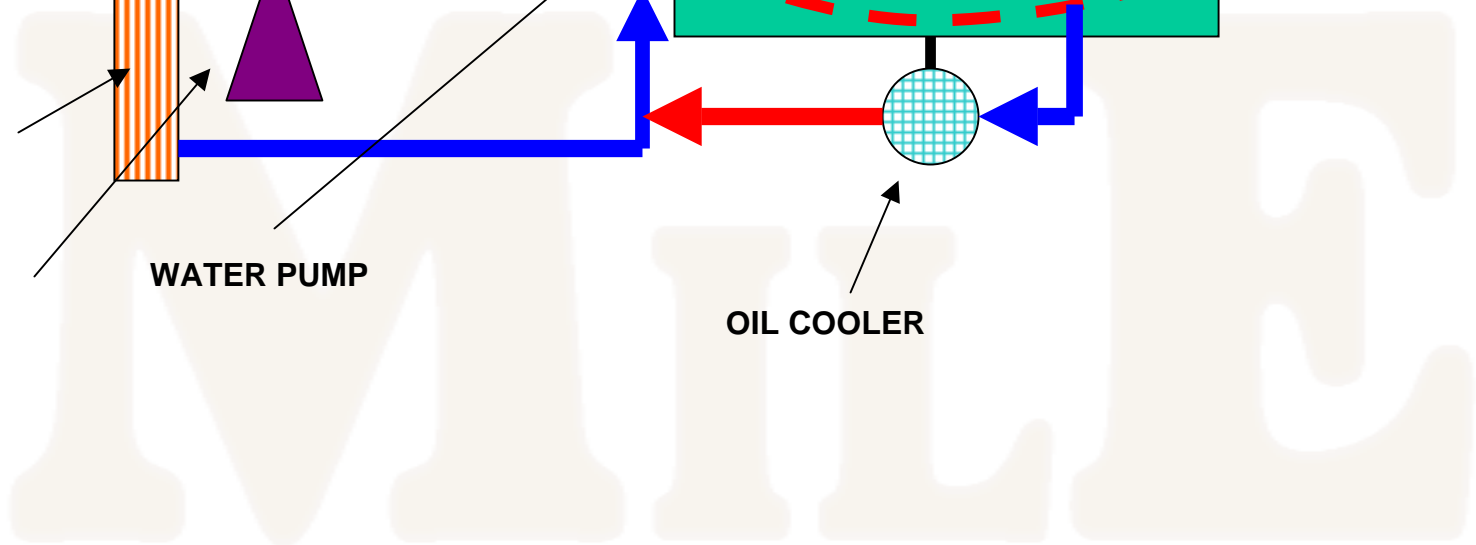

BASIC SYSTEM

COOLING SYSTEM

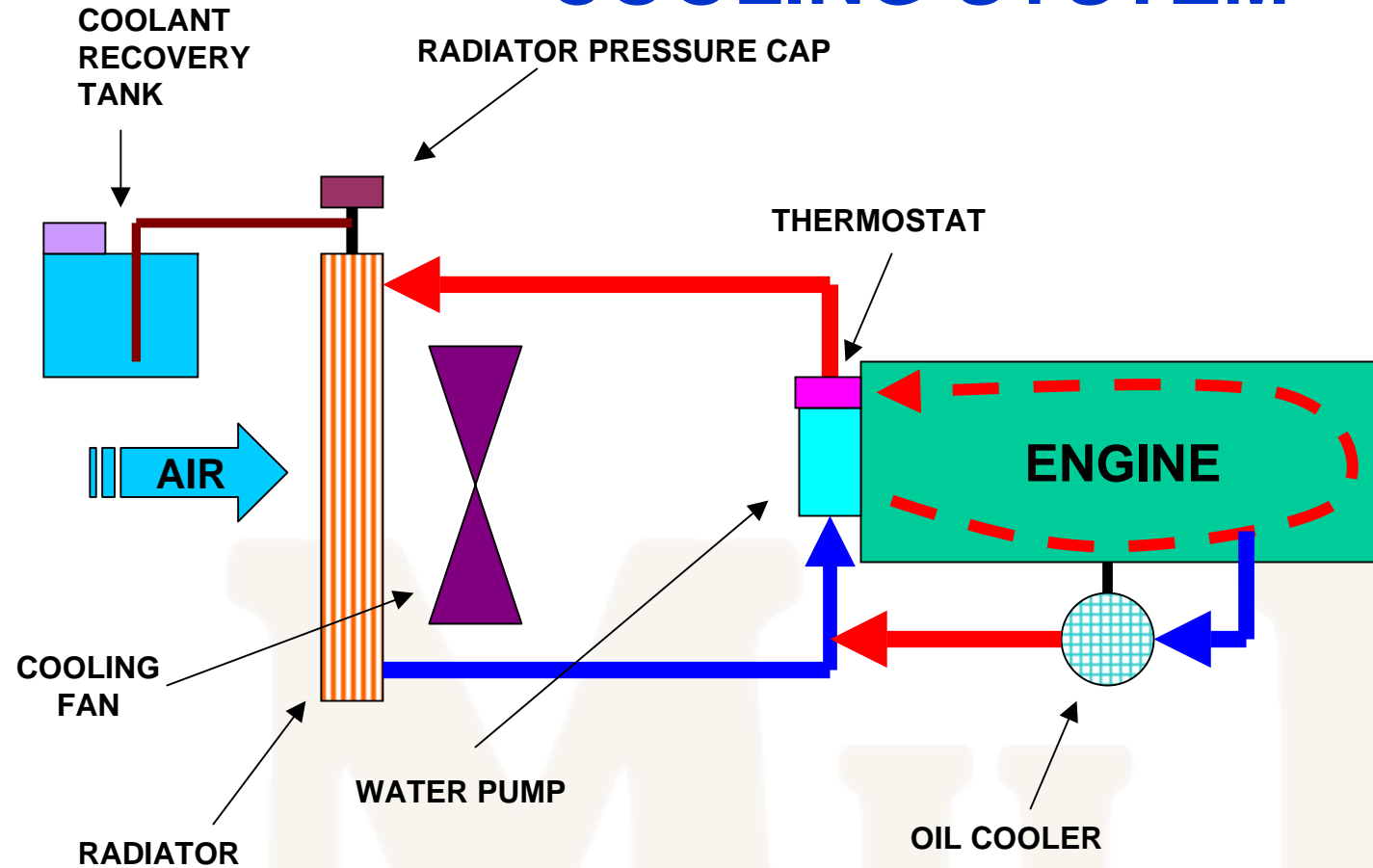

COOLANT RECOVERY SYSTEM (No Loss System)

- SCORPIO DIESEL
- ALL UV MODELS

COOLING SYSTEM

DEGASSING TANK

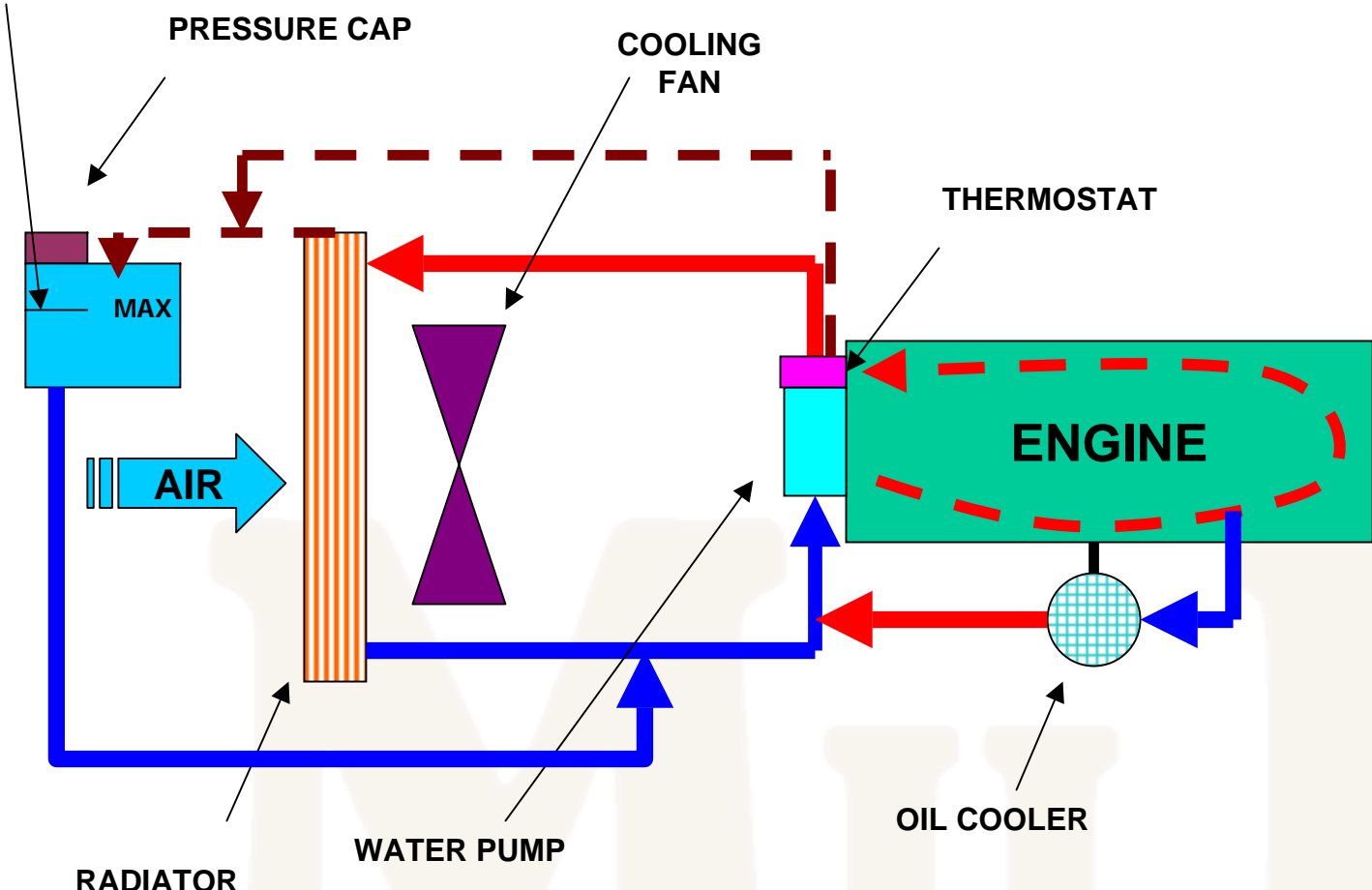

--- GASES

**DEGASSING TANK SYSTEM
(No Loss System & Degassing)**

- BOLERO
- SCORPIO PETROL

COOLING SYSTEM

1. WATER PUMP - Water pump sucks water from the radiator bottom tank and pushes the water in to the engine block/cylinder head. Water pump is driven by the engine crankshaft by a belt (in some cases it may be gear driven)

2. THERMOSTAT - Thermostat is a temperature sensitive valve fitted on the outlet of the engine. The thermostat will open only when the predetermined temperature (75-90 C) is reached. Thermostat ensures that a cold engine warms up faster and also ensures engine runs at optimum temperature for best fuel efficiency.

2.RADIATOR - Radiator is a heat exchanger. The hot coolant (water) from engine enters to the top tank of the radiator and passes through the core to the bottom tank of the radiator. Cool atmospheric air is drawn over the core by the cooling fan, leading to cooling of the radiator water. Radiators can be of :

Down Flow type - Water passes from top tank to bottom tank in a downward direction.

Cross Flow type - Water passes from left to right across the radiator.

Radiators can be made of **Copper or Aluminum**

COOLING SYSTEM

4. RADIATOR PRESSURE CAP - Water normally starts boiling at 100 deg C. In order to increase the boiling temperature of water, the cooling system is pressurized. The Radiator pressure cap is set at 0.9 Bar so that the cooling system operates under a pressure of 1.9 Bar. When the pressure exceeds 1.9 Bar, the pressure valve opens and lets out the excessive pressure along with some coolant. When the engine cools down, the vacuum valve opens and let in air so that the radiator does not collapse inwards due to vacuum.

5. COOLING FAN - Cooling fan sucks in fresh cool air through the radiator, thus cooling the hot water. Cooling fan can be of 3 types based on how it is driven & controlled.

MECHANICAL FAN - Is driven by the engine crankshaft by a belt. Cooling fan speed is dependent on engine speed.

VISCOUS FAN(Scorpio - Diesel) - Is driven by the engine by a belt. However, the speed of the fan is controlled by a viscous clutch based on the radiator temperature.

ELECTRIC FAN(Scorpio - Petrol)- Is driven by an electric motor. The motor is controlled by a controller based on various parameters like engine temperature, engine speed, A/c operation etc.

COOLING SYSTEM

6. OIL COOLER - Oil cooler is a heat exchanger which uses coolant to cool the engine oil. The hot engine oil is passed through the inside of the oil cooler and a relatively cool coolant flows on the outside.

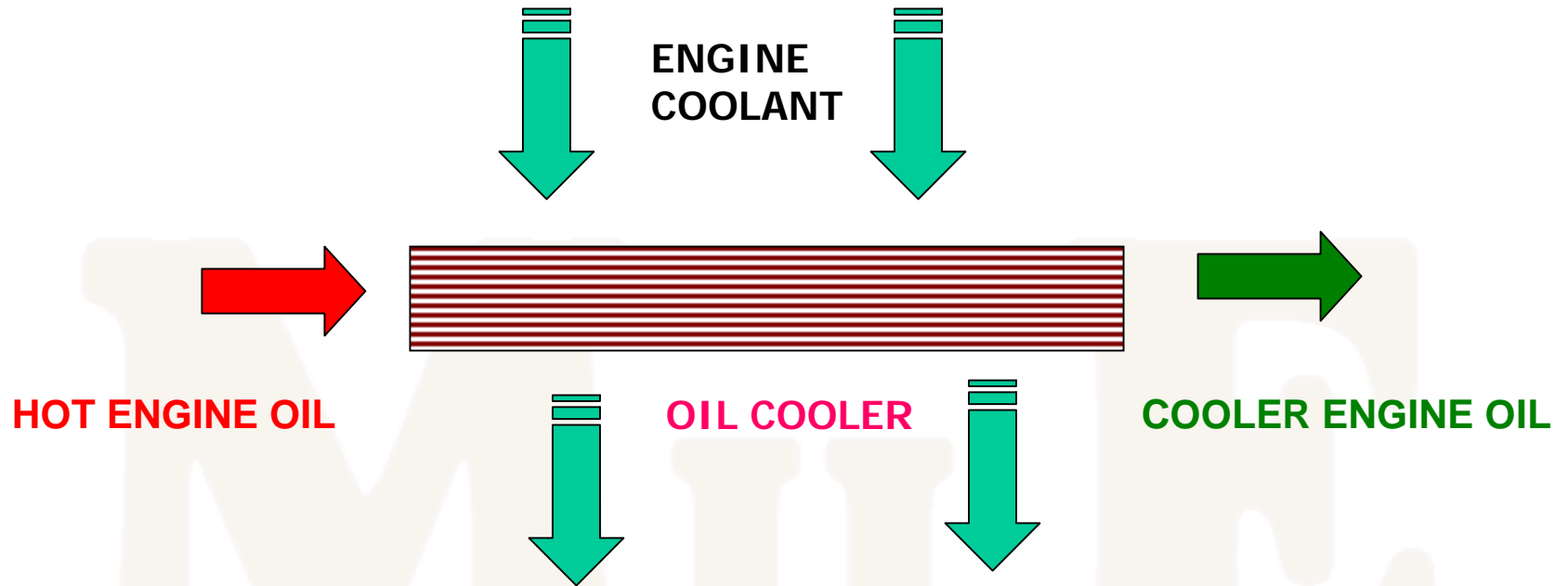

SAMPLE LEAFLET



Engine3.exe

MARSHAL 2000

ENGINE	: MDI 3200 L ; DIRECT INJECTION DIESEL
TYPE	: 4 STROKE, 4 CYLINDER, INLINE
BORE/STROKE	: 88.9 mm/101.6 mm
CUBIC CAPACITY	: 2523 cc
MAX POWER	: 58 HP @ 3200 RPM
MAX TORQUE	: 16.55 Kg-m @ 1500 RPM
FUEL INJ SYSTEM	: INLINE
COMPRESSION RATIO	: 18 : 1
WEIGHT	: 260 Kg
COOLING SYSTEM	: BELT DRIVEN PUMP ON CYLINDER HEAD THERMOSTAT CONTROLLED

SYSTEMS IN AN AUTOMOBILE

A. POWER TRAIN SYSTEM

- **POWER PLANT (POWER GENERATION - ENGINE)**

- **ENGINE**
- **FUEL SYSTEM**
- **INTAKE SYSTEM**
- **EXHAUST SYSTEM**
- **COOLING SYSTEM**

- **DRIVE LINE (POWER TRANSMISSION)**



- **CLUTCH**
- **GEAR BOX/TRANSMISSION**
- **TRANSFER CASE**
- **DIFFERENTIAL**
- **WHEELS/TYRES**

B. RUNNING SYSTEM

- **SUSPENSION**
- **STEERING**
- **BRAKING**

C. COMFORT SYSTEM

- **HVAC/AC/HEATER SYSTEM**
- **SEATING/UPHOLSTRY/FACIA/INSTRUMENTS**
- **AUDIO/VIDEO/GPS**

ANATOMY OF AN AUTOMOBILE - DRIVELINE

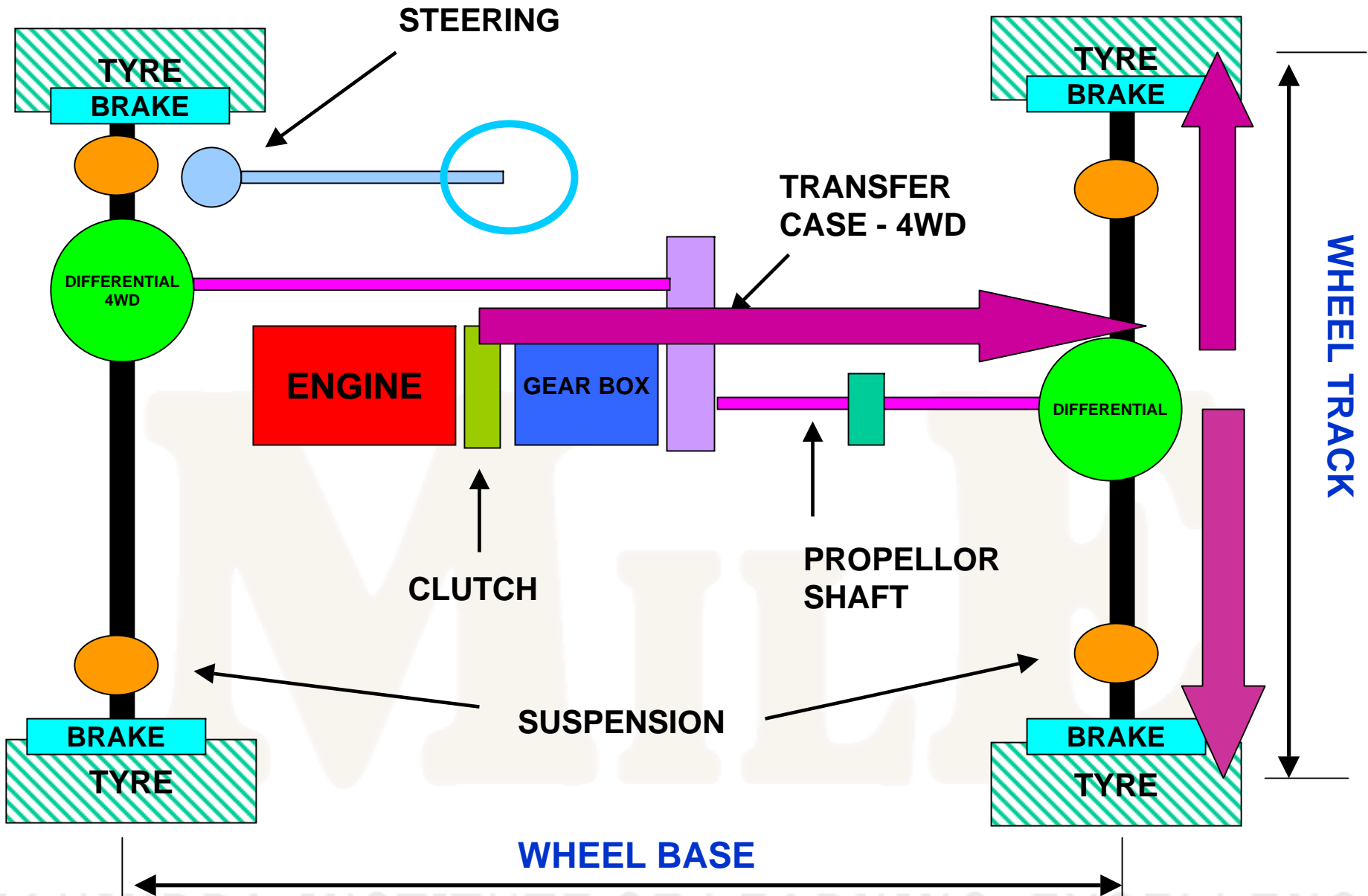

DRIVELINE - POWER TRANSMISSION

POWER IS GENERATED BY THE POWER PLANT (ENGINE)

THE GENERATED POWER NEEDS TO BE MODIFIED & TRANSMITTED TO THE WHEELS FOR VEHICLE LOCOMOTION.

DRIVELINE MODIFIES & TRANSMITS THE POWER/TORQUE TO THE WHEELS OF THE AUTOMOBILE.

COMPONENTS OF DRIVELINE

- CLUTCH
- PROPELLOR SHAFT
- DIFFERENTIAL
- AXLE SHAFTS
- WHEELS
- TYRES

SYSTEMS IN AN AUTOMOBILE

A. POWER TRAIN SYSTEM

- **POWER PLANT (POWER GENERATION - ENGINE)**

- **ENGINE**
- **FUEL SYSTEM**
- **INTAKE SYSTEM**
- **EXHAUST SYSTEM**
- **COOLING SYSTEM**

- **DRIVE LINE (POWER TRANSMISSION)**

- **CLUTCH**
- **GEAR BOX/TRANSMISSION**
- **TRANSFER CASE**
- **DIFFERENTIAL**
- **WHEELS/TYRES**



B. RUNNING SYSTEM

- **SUSPENSION**
- **STEERING**
- **BRAKING**

C. COMFORT SYSTEM

- **HVAC/AC/HEATER SYSTEM**
- **SEATING/UPHOLSTRY/FACIA/INSTRUMENTS**
- **AUDIO/VIDEO/GPS**

CLUTCH SYSTEM

CLUTCH IS THE CRUCIAL **LINK** BETWEEN THE POWER PLANT (ENGINE) AND THE DRIVELINE

THE PURPOSE OF THE CLUTCH IS TO **LINK OR DE-LINK(ENGAGE OR DIS-ENGAGE)** THE ENGINE FROM THE DRIVELINE, AS DESIRED BY THE DRIVER

COMPONENTS OF CLUCH

- CLUTCH ACTUATION MECHANISM
 - LINK TYPE
 - CABLE TYPE
 - HYDRAULIC TYPE
- CLUTCH CABLE
- CLUTCH MASTER CYLINDER
- CLUTCH SLAVE CYLINDER
- RELEASER BEARING
- CLUTCH PRESSURE PLATE
- CLUTCH DRIVEN PLATE

CLUTCH SYSTEM

ENGAGED

CLUTCH PEDAL -FREE

LINKED

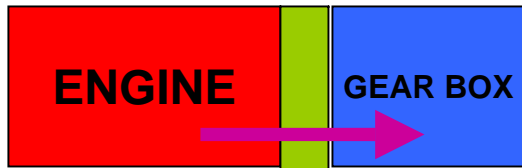

CLUTCH

CLUTCH ACTUATION MECHANISM

DIS-ENGAGED

CLUTCH PEDAL -PRESSED

DE-LINKED

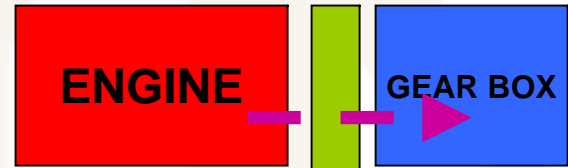

ENGINE

GEAR BOX

CLUTCH ACTUATION MECHANISM

The clutch operating mechanism transfers the force exerted by the driver at the clutch pedal to the clutch and either engages or disengages the clutch.

Clutch actuation mechanism can be classified as :

- 1. Mechanical Clutch** - Where the driver's foot effort is transmitted to the clutch through a set of levers and links
- 2. Cable Clutch** - Where the driver's foot effort is transmitted to the clutch through a cable.
- 3. Hydraulic Clutch** - Where the driver's foot effort is transferred to a hydraulic oil medium, which in turn operates the clutch through master cylinder & slave cylinder. Pedal efforts are lower & doesnot require clutch pedal free play adjustments.

HYDRAULIC CLUTCH SYSTEM

ENGAGED

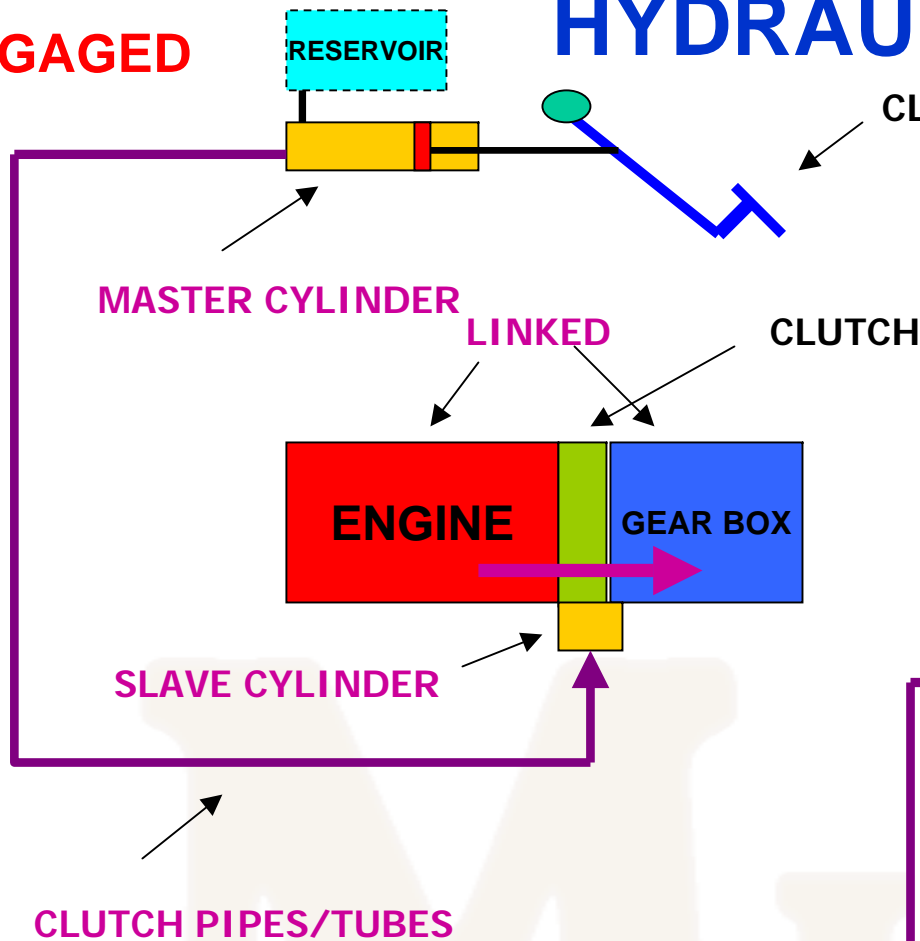

DIS-ENGAGED

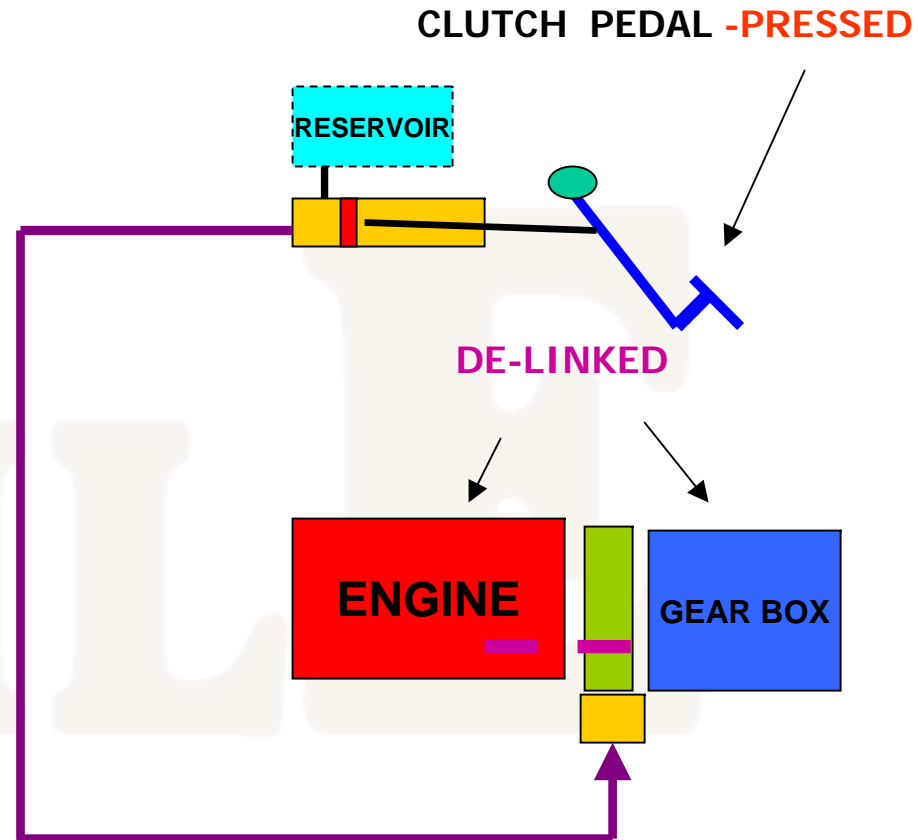

HYDRAULIC CLUTCH SYSTEM

- 1. CLUTCH MASTER CYLINDER** - Converts driver's foot effort to hydraulic pressure and transmits the pressure to clutch slave cylinder
- 2. CLUTCH SLAVE CYLINDER** - Receives the hydraulic pressure from Clutch master cylinder and moves the clutch fork to either disengage or engage the clutch mechanism
- 3. CLUTCH PIPES/TUBES** - The connection between the Clutch master cylinder and Clutch slave cylinder, transmitting the hydraulic fluid.
- 4. RESERVOIR** - The storage for clutch fluid

CLUTCH MECHANISM

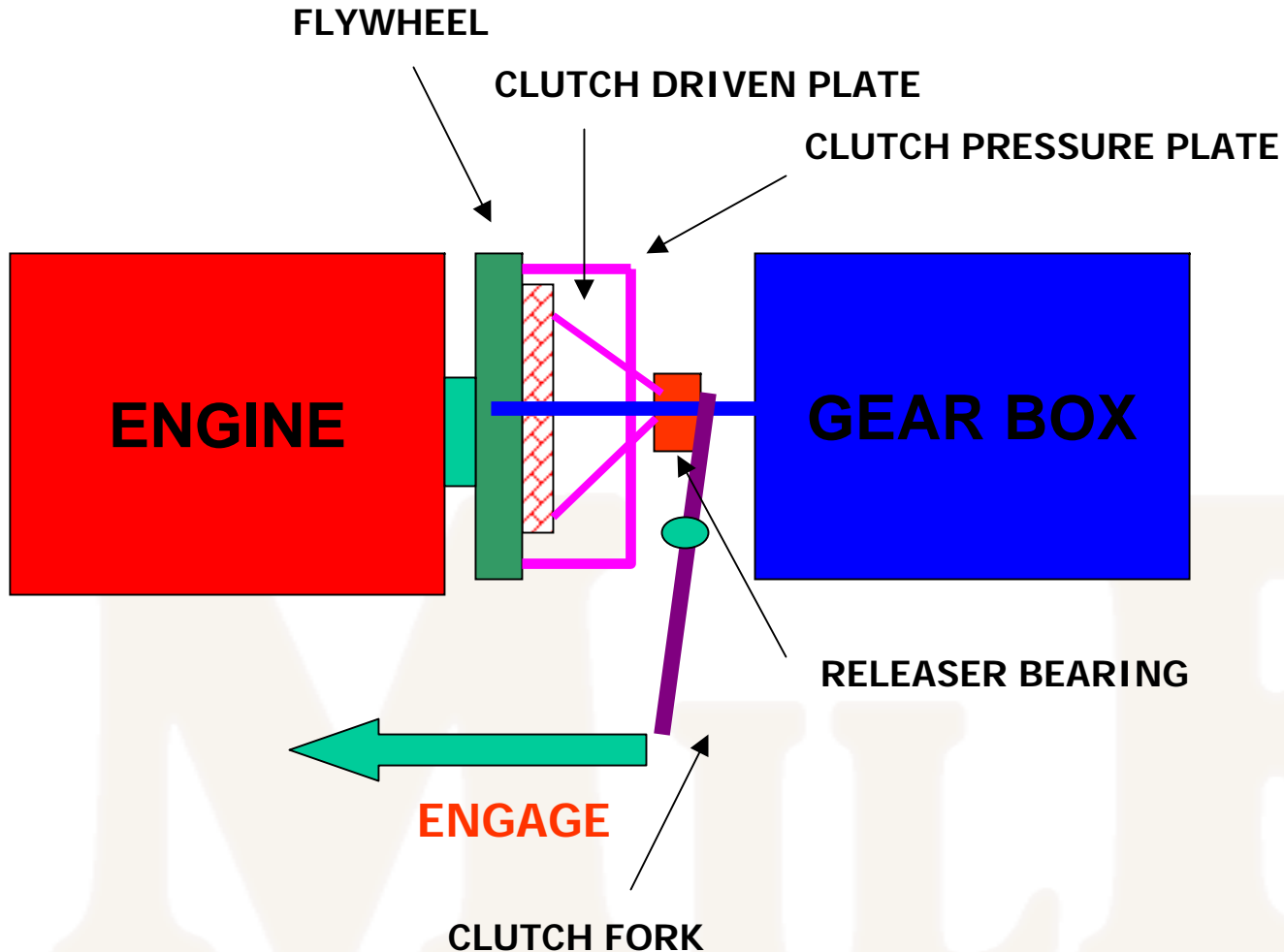

**CLUTCH PEDAL FREE
CLUTCH ENGAGED**

CLUTCH MECHANISM

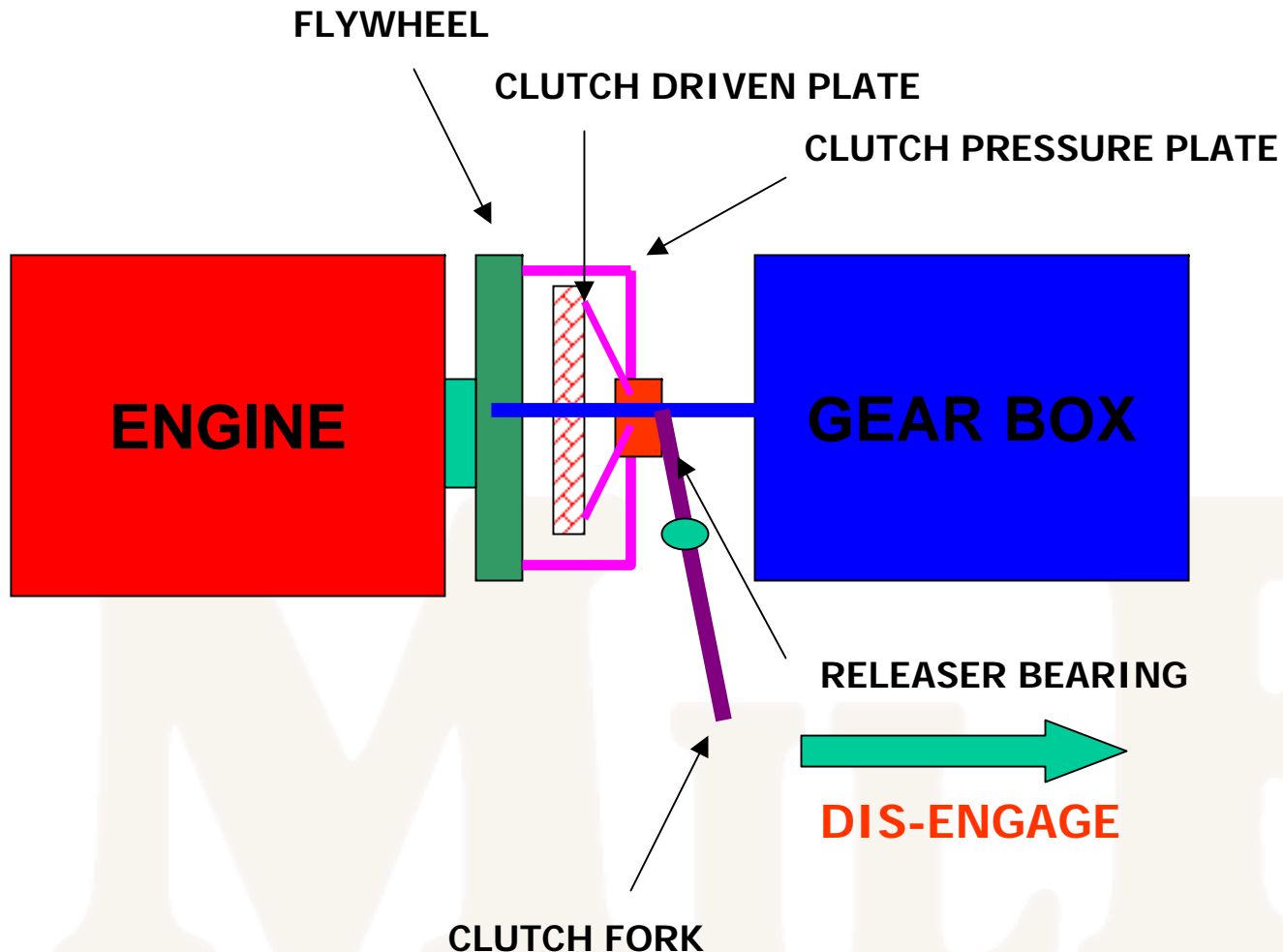

**CLUTCH PEDAL PRESSED
CLUTCH DISENGAGED**

CLUTCH MECHANISM

1. CLUTCH DRIVEN PLATE - Clutch pressure plate is the link between the engine & gear box transmitting power & torque to the driveline. In engaged condition, the clutch plate is sandwiched between the engine flywheel & the Clutch pressure plate.

2. CLUTCH PRESSURE PLATE - Clutch pressure plate ensures that the clutch plate is clamped tightly to the flywheel in engaged condition and releases the clutch plate from flywheel in dis-engaged condition. The drivers' foot effort is transmitted to the clutch pressure plate through the actuation mechanism and the releaser bearing.

3. RELEASER BEARING

4. CLUTCH FORK



Clutch2.exe

SAMPLE LEAFLET

MARSHAL 2000

CLUTCH

**: MECHANICALLY ACTUATED, SINGLE DRY PLATE
23.5 cm DIA**

MILLE

SYSTEMS IN AN AUTOMOBILE

A. POWER TRAIN SYSTEM

- **POWER PLANT (POWER GENERATION - ENGINE)**

- **ENGINE**
- **FUEL SYSTEM**
- **INTAKE SYSTEM**
- **EXHAUST SYSTEM**
- **COOLING SYSTEM**

- **DRIVE LINE (POWER TRANSMISSION)**

- **CLUTCH**
- **GEAR BOX/TRANSMISSION**
- **TRANSFER CASE**
- **DIFFERENTIAL**
- **WHEELS/TYRES**



B. RUNNING SYSTEM

- **SUSPENSION**
- **STEERING**
- **BRAKING**

C. COMFORT SYSTEM

- **HVAC/AC/HEATER SYSTEM**
- **SEATING/UPHOLSTRY/FACIA/INSTRUMENTS**
- **AUDIO/VIDEO/GPS**

GEAR BOX

(TRANSMISSION)

GEAR BOX **MODIFIES & TRANSMITS** THE TORQUE OF THE ENGINE TO THE DRIVE LINE.

THE AMOUNT OF MODIFICATION OF TORQUE REQUIRED IS DECIDED BY THE DRIVER AND IS ACTUATED BY A GEAR LEVER WHICH SELECTS A REQUIRED GEAR RATIO.

COMPONENTS OF GEAR BOX

- GEAR BOX
- GEAR SELECTION LEVER

GEAR BOX

(TRANSMISSION)

GEAR BOXES ARE CLASSIFIED AS :

- **STEPPED TRANSMISSION**
- **STEPLESS TRANSMISSION** (USED MOSTLY IN 2 WHEELERS)

STEPPED TRANSMISSION ARE GEAR BOXES WHICH HAS DEFINED STEPS OR GEAR RATIOS. THE NUMBER OF STEPS CAN BE 3 , 4 OR 5.

STEPPED TRANSMISSIONS CAN BE FURTHER CLASSIFIED AS

MANUAL TRANSMISSION WHERE THE REQUIRED STEP OR GEAR IS SELECTED BY THE DRIVER, AS PER THE DRIVING REQUIREMENT

AUTOMATIC TRANSMISSION WHERE THE STEP OR GEAR RATIO IS AUTOMATICALLY SELECTED, AS DECIDED BY A ECU BASED ON INFORMATION FROM VARIOUS SENSORS

GEAR BOX (MANUAL TRANSMISSION)

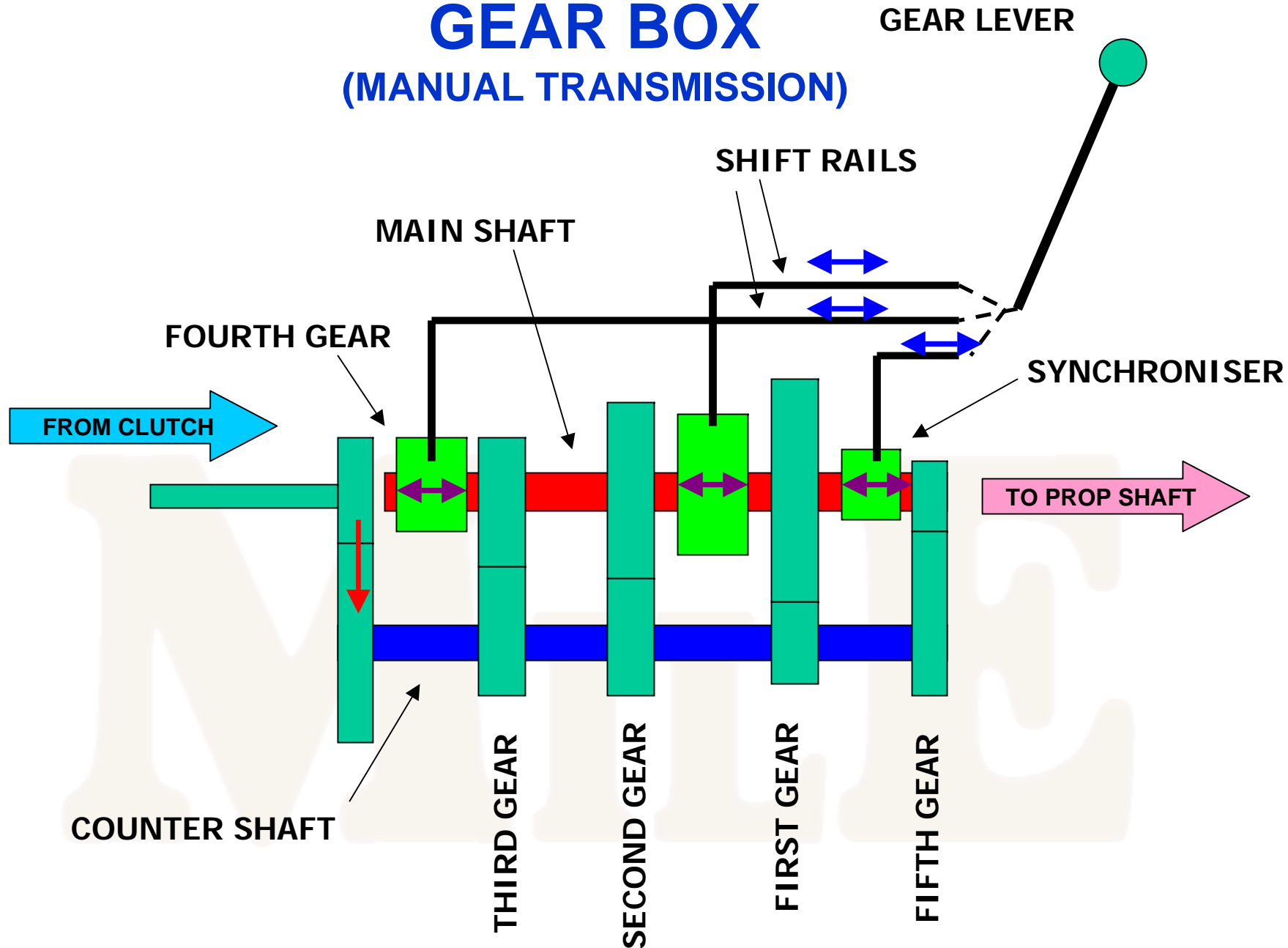

REVERSE GEAR NOT SHOWN

GEAR BOX

GEAR RATIO - Gear ratios are gear reduction steps in the gear box. A gear reduction multiplies the engine torque by the gear ratio amount. Torque requirement at the wheel depends on operating conditions. For example :

To move a vehicle from standstill requires much more torque than the peak torque of the engine. Hence the torque is multiplied by the first gear ratio.

Once the vehicle is started and moved using first gear, it requires less torque at the wheels to keep it moving. Hence it requires no multiplication or very less multiplication.

If the vehicle suddenly encounters a gradient , it will require more torque at the wheels to keep the vehicle moving. Hence an intermediate ratio is required.

GEAR BOX

GEAR CHANGE MECHANISM(EXTERNAL) - A desired gear ratio can be selected by the driver by **selecting and shifting** the gear lever

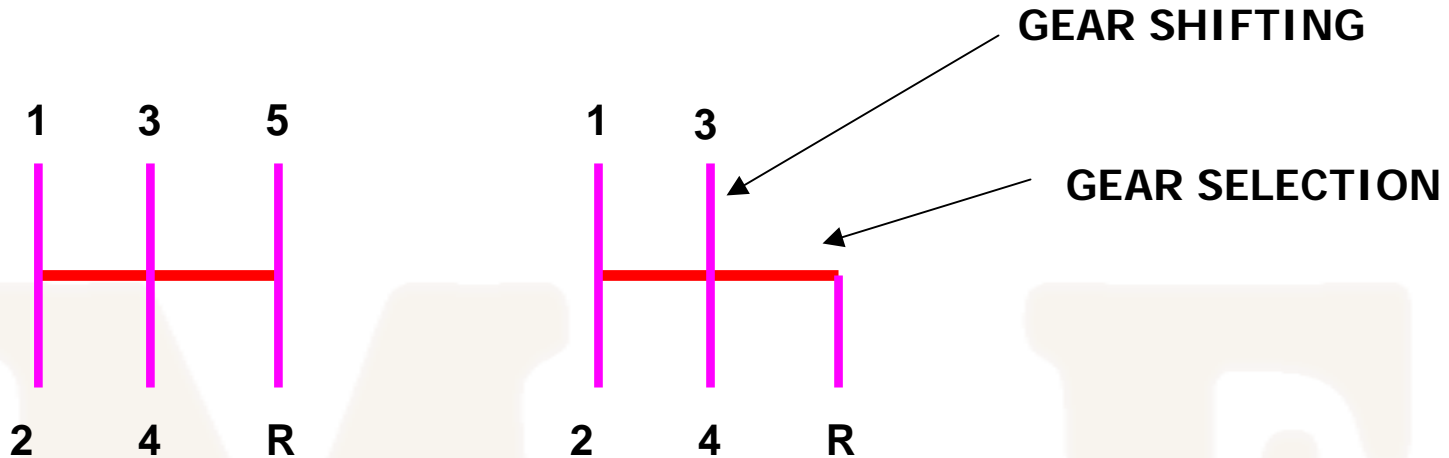

5 SPEED TRANSMISSION

- BA10
- NISSAN
- ISUZU

4 SPEED TRANSMISSION

- KMT 90
- MS 90

GEAR BOX

GEAR CHANGE MECHANISM(INTERNAL) - The desired gear ratio selected by the driver is transmitted through the gear lever, set of shift rails to the gears located inside the gear box.

The gear shifting mechanism inside the gear box can be broadly classified as :

SLIDING MESH - In which , the gears needs to be moved physically in to mesh with the corresponding gear. This requires that the vehicle is stationary when the gears are shifted, Hence sliding mesh is obsolete and is used only in First Gear or Reverse gear.

CONSTANT MESH - In which, all the gears are in constant mesh and the required gear engagement is achieved by operating a **synchroniser mechanism**. Synchronisation mechanism can be classified as :

Manual Synchronisation - As in Leyland trucks - Double de-clutching

Automatic Synchronisation - Single stroke shifting

GEAR BOX

SYNCHRONISER MECHANISM - In order to avoid gears crashing, when shifting from one gear ratio to another, it is required to match the speeds of both the drive & the driven gears, before the shifting can happen.

Synchroniser mechanism does the job of synchronising the speeds of the drive & driven gear so that shifting takes place smoothly.

All forward gears (except First) need to have synchronisers

Synchroniser mechanism are of different designs :

Strut type - As in KMT 90 gear box/Isuzu Gear box

Pin Type - As in BA10 gear box



SAMPLE LEAFLET

MARSHAL 2000

TRANSMISSION : 4 SPEED, 2nd, 3rd & 4th Synchromesh
1st GEAR - 3.986 : 1
2nd GEAR - 2.368 : 1
3rd GEAR - 1.473 : 1
4th GEAR - 1.000 : 1
REVERSE - 5.315 : 1

MILLE

SYSTEMS IN AN AUTOMOBILE

A. POWER TRAIN SYSTEM

- **POWER PLANT (POWER GENERATION - ENGINE)**

- **ENGINE**
- **FUEL SYSTEM**
- **INTAKE SYSTEM**
- **EXHAUST SYSTEM**
- **COOLING SYSTEM**

- **DRIVE LINE (POWER TRANSMISSION)**

- **CLUTCH**
- **GEAR BOX/TRANSMISSION**
- **TRANSFER CASE**
- **DIFFERENTIAL**
- **WHEELS/TYRES**



B. RUNNING SYSTEM

- **SUSPENSION**
- **STEERING**
- **BRAKING**

C. COMFORT SYSTEM

- **HVAC/AC/HEATER SYSTEM**
- **SEATING/UPHOLSTRY/FACIA/INSTRUMENTS**
- **AUDIO/VIDEO/GPS**

TRANSFER CASE

TRANSFER CASES ARE FITTED ONLY IN 4WD VEHICLES

TRANSFER CASE **MODIFIES & RE-DIRECTS** THE TORQUE OF THE ENGINE TO **BOTH FRONT AND REAR AXLES**, AS DESIRED.

4WD VEHICLES CAN BE CLASSIFIED AS :

FULL TIME 4WD - Where all the 4 wheels are connected to the engine, permanently. Also known as **All Wheel Drive(AWD)**

PART TIME 4WD - Where either 2WD mode or 4WD mode can be selected by the driver by shifting a gear lever (**Manual shift**) or by turning a switch (**Electric shift**)

ANATOMY OF AN AUTOMOBILE (FOUR WHEEL DRIVE)

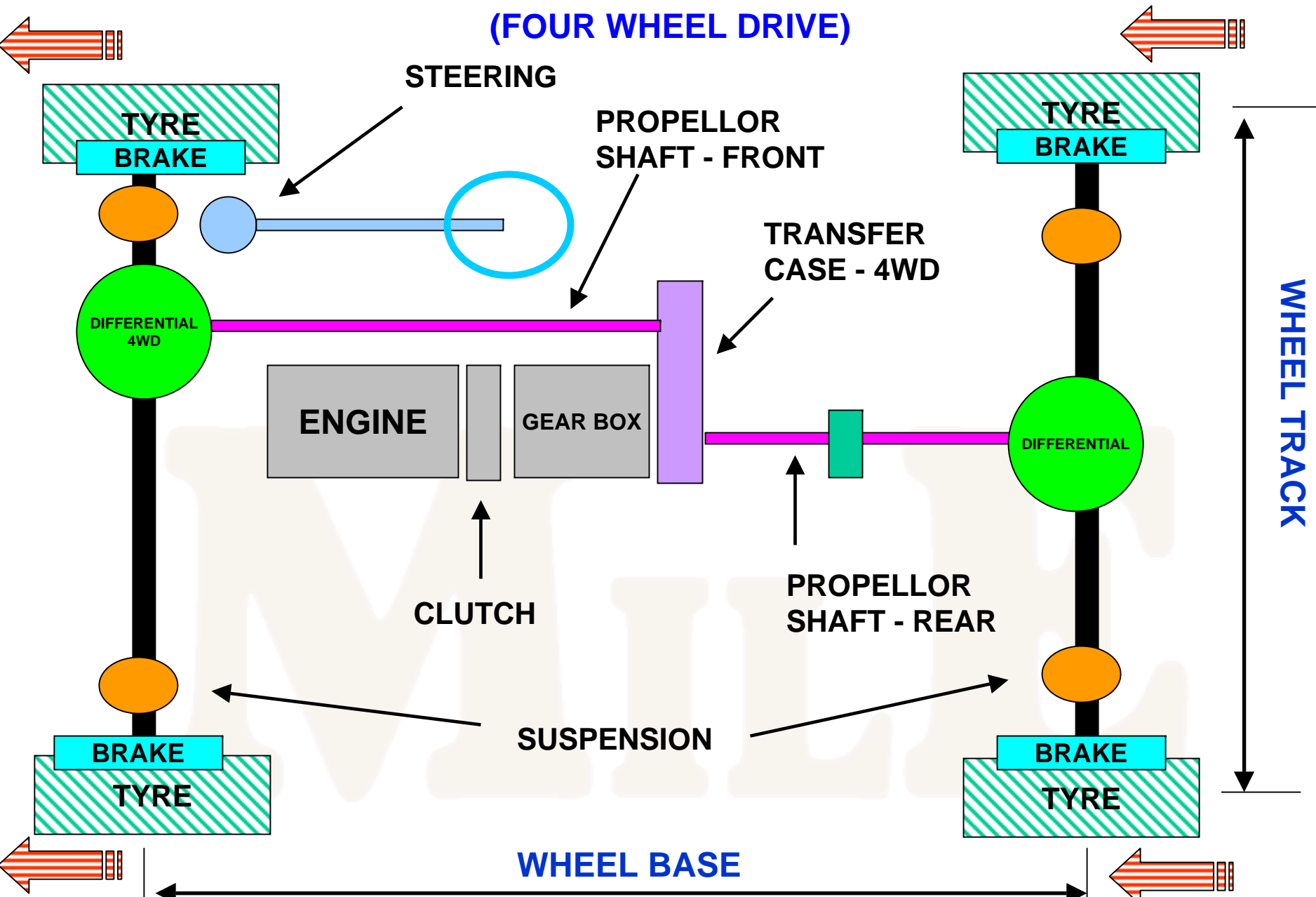

TRANSFER CASE

M&M USES 2 TYPES OF TRANSFER CASES , NAMELY :

T-18 TRANSFER CASE - Fitted on all Utility vehicles. T-18 is 2 gear transfer case - High gear & Low gear, mechanically shifted.

HIGH GEAR RATIO - 1 : 1

LOW GEAR RATIO - 2.46 : 1

All the gears are of **sliding mesh type** , hence the vehicle needs to be brought to standstill before shifting.

BORG-WARNER TRANSFER CASE - Fitted on Scorpio & Bolero. BW is a 2 gear transfer case - High gear & low gear, mechanically or electrically shifted.

HIGH GEAR RATIO - 1 : 1

LOW GEAR RATIO - 2.48 : 1

Gear reduction is through **planetary gear system & Chain**

TRANSFER CASE

(T-18)

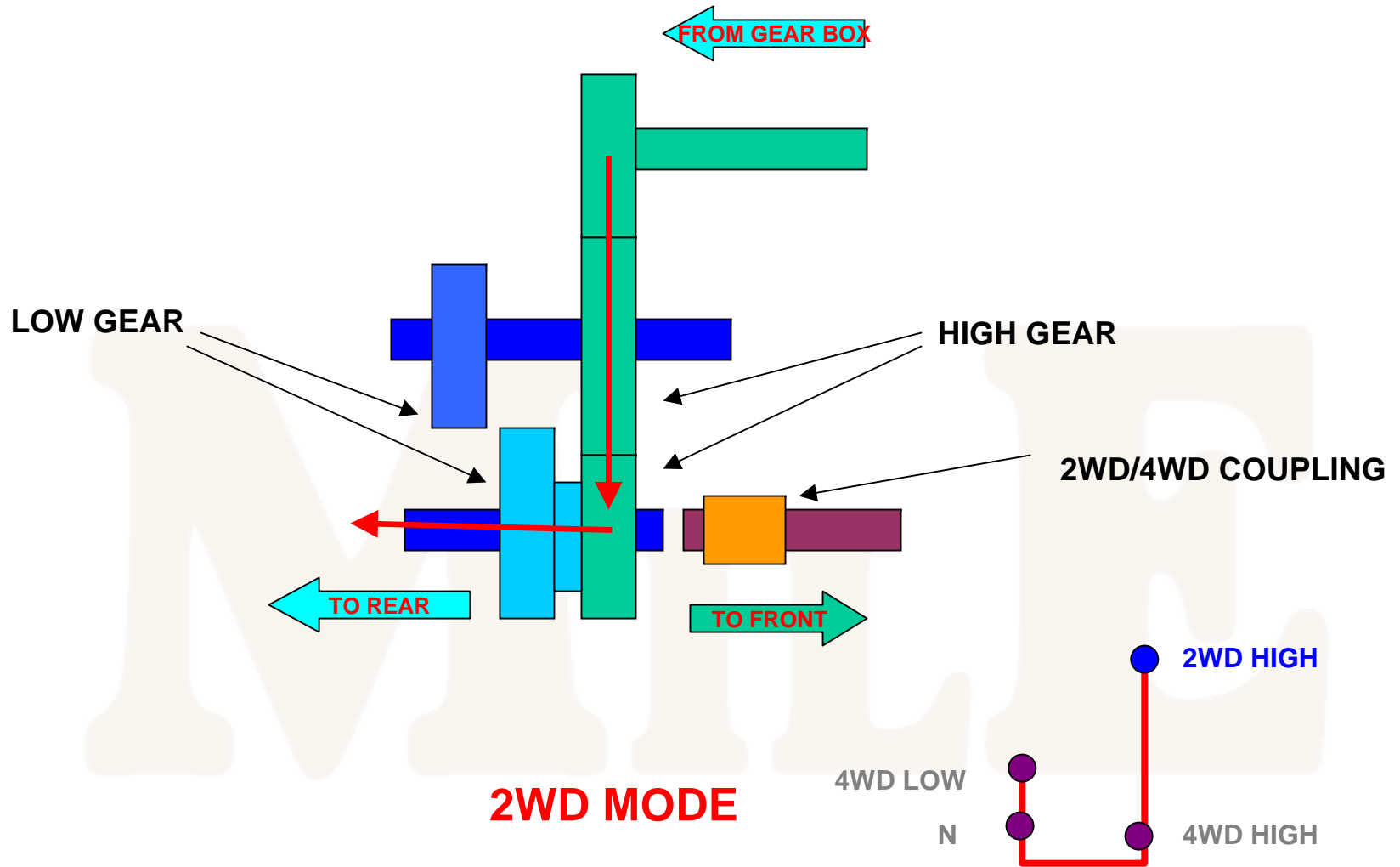

TRANSFER CASE (BORG-WARNER)

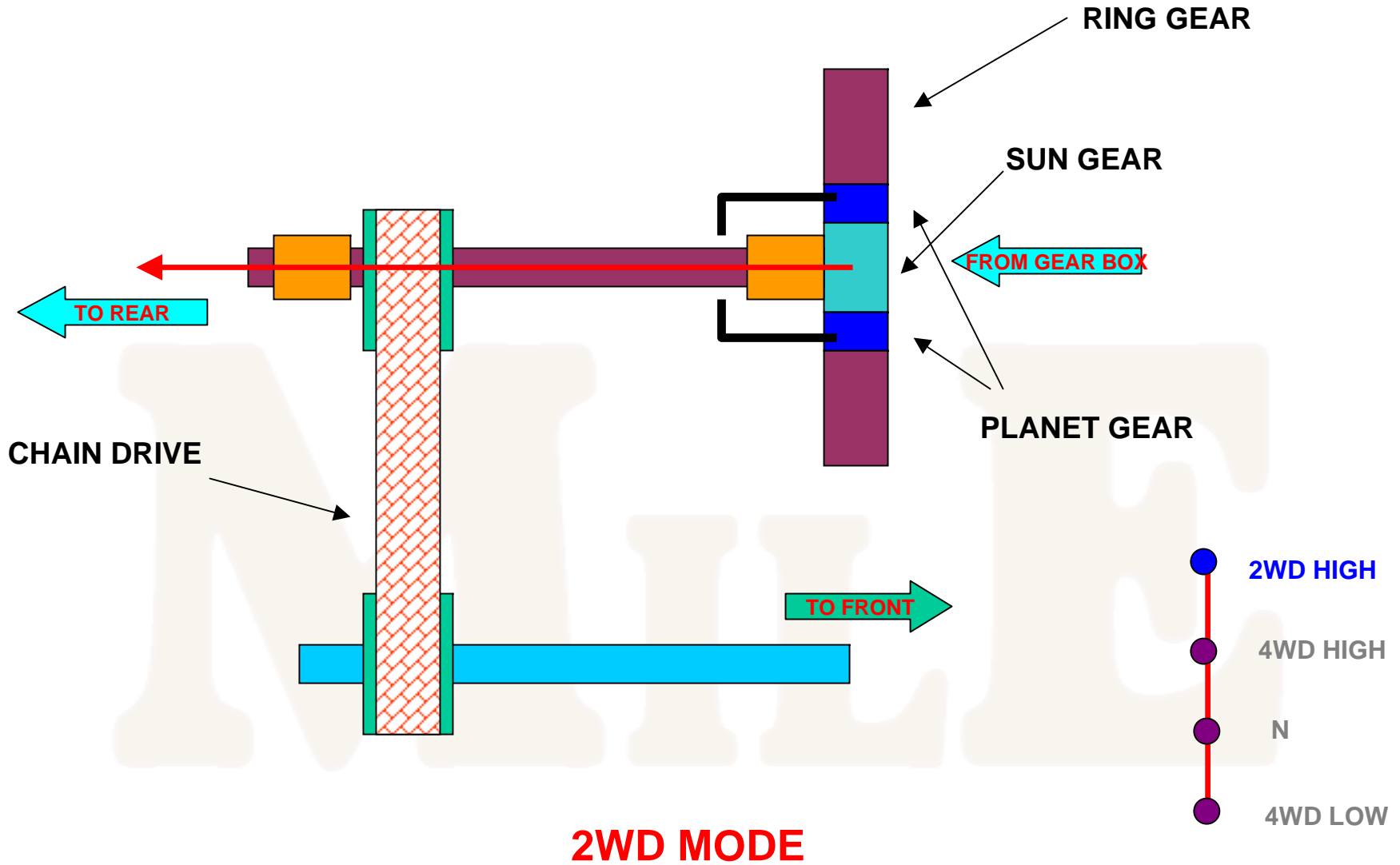

2WD MODE

TRANSFER CASE

(BORG-WARNER)

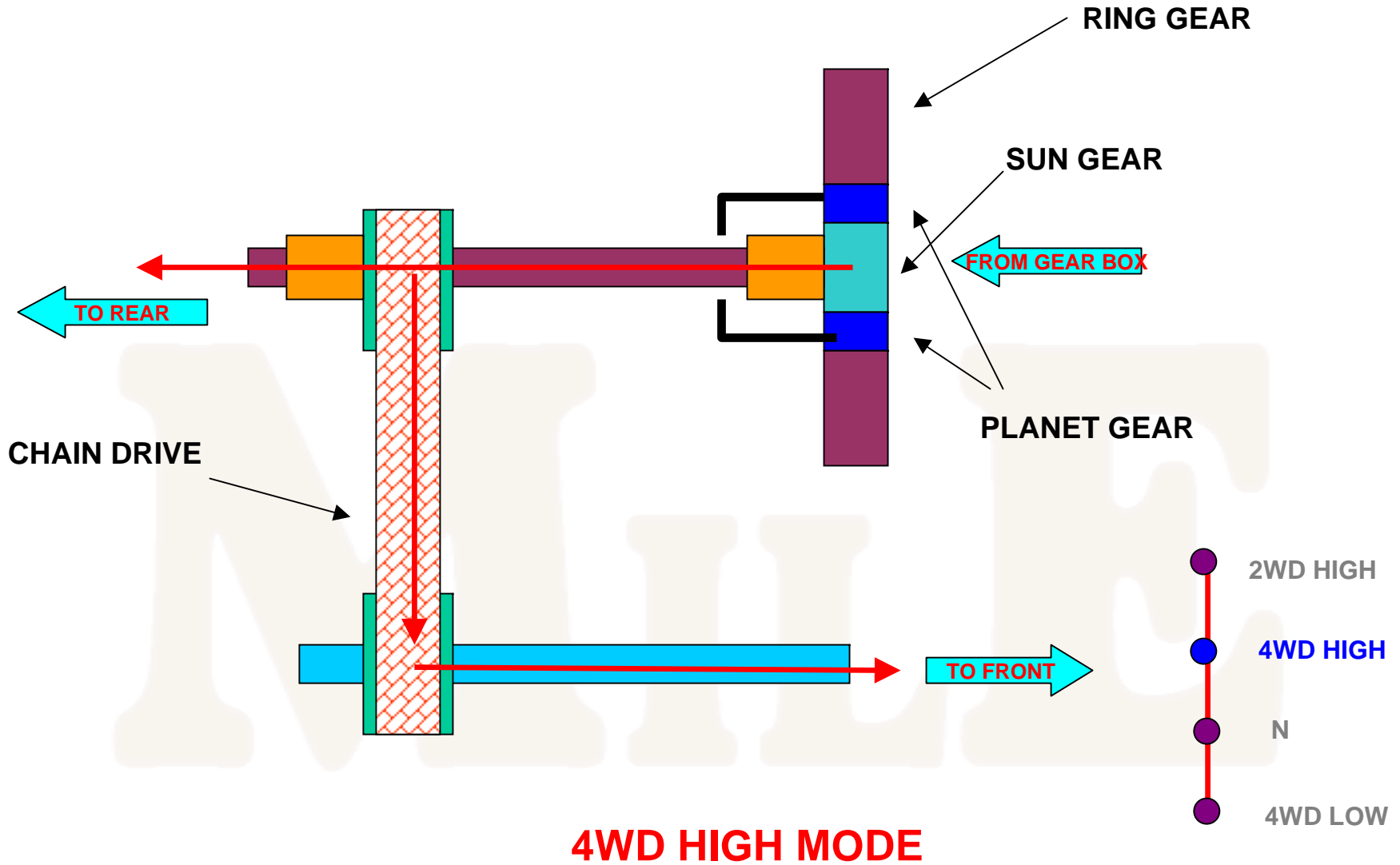

TRANSFER CASE (BORG-WARNER)

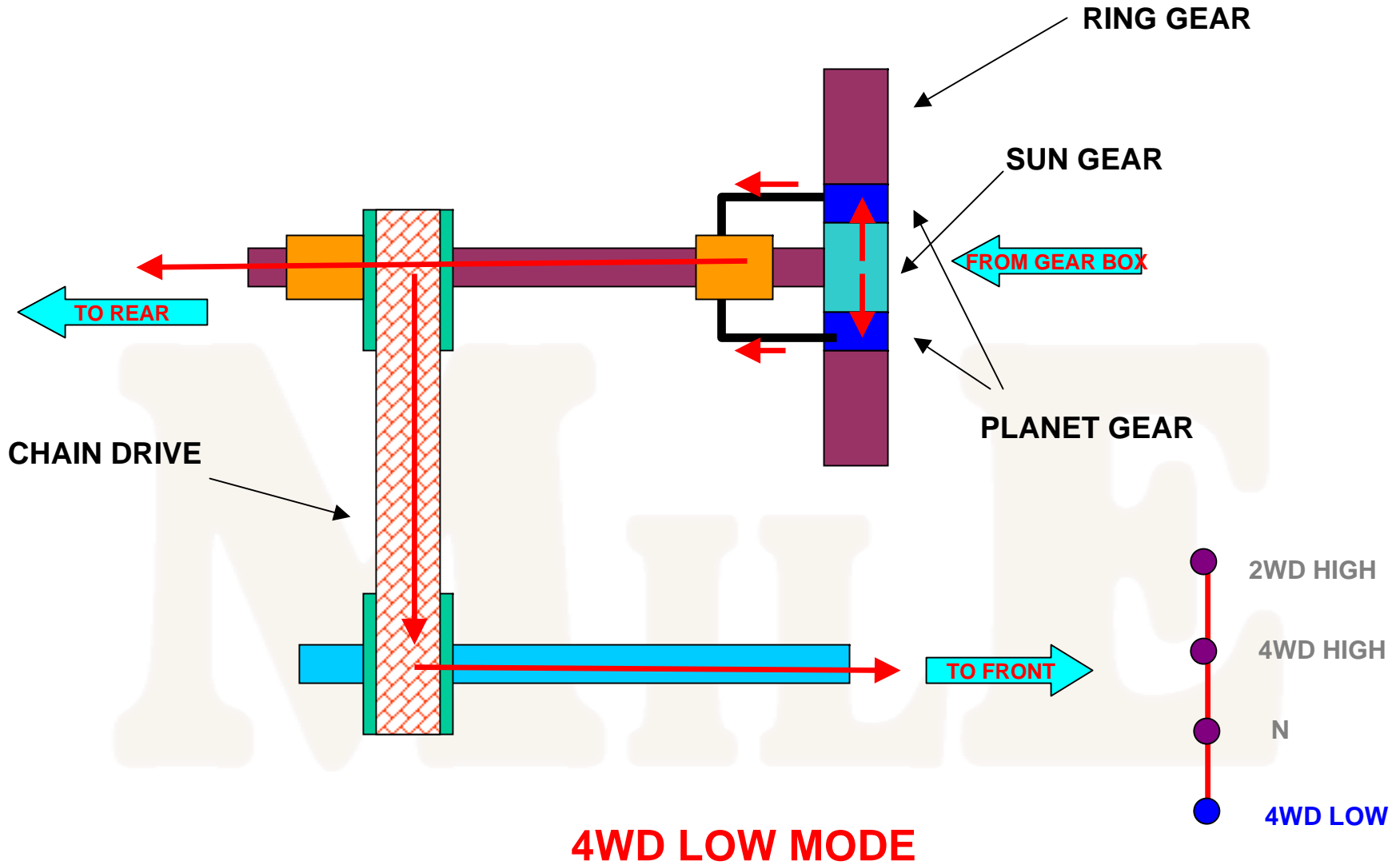

SAMPLE LEAFLET

MARSHAL 2000

TRANSFER CASE

: TWO SPEED GEAR REDUCTION

SINGLE SHIFT LEVER

SPEED RATIO : HIGH - 1 : 1 , LOW 2.46 : 1

MILLE

PROPELLOR SHAFT

PROPELLOR SHAFT **TRANSMITS** THE ENGINE TORQUE FROM THE GEAR BOX/TRANSFER CASE TO THE DIFFERENTIAL.

PROPELLOR SHAFTS CAN BE EITHER :

SINGLE PROPELLOR SHAFT

SPLIT PROPELLOR SHAFT

MILE

SYSTEMS IN AN AUTOMOBILE

A. POWER TRAIN SYSTEM

- **POWER PLANT (POWER GENERATION - ENGINE)**

- **ENGINE**
- **FUEL SYSTEM**
- **INTAKE SYSTEM**
- **EXHAUST SYSTEM**
- **COOLING SYSTEM**

- **DRIVE LINE (POWER TRANSMISSION)**

- **CLUTCH**
- **GEAR BOX/TRANSMISSION**
- **TRANSFER CASE**
- **DIFFERENTIAL**
- **WHEELS/TYRES**



B. RUNNING SYSTEM

- **SUSPENSION**
- **STEERING**
- **BRAKING**

C. COMFORT SYSTEM

- **HVAC/AC/HEATER SYSTEM**
- **SEATING/UPHOLSTRY/FACIA/INSTRUMENTS**
- **AUDIO/VIDEO/GPS**

DIFFERENTIAL

DIFFERENTIAL RECEIVES TORQUE FROM THE GEAR BOX, **MODIFIES AND TRANSMITS** IT TO THE WHEELS, IN A PERPENDICULAR DIRECTION.

DIFFERENTIAL ALSO ALLOWS **EACH WHEEL TO ROTATE AT DIFFERENT SPEEDS**, ESPECIALLY WHEN THE VEHICLE TAKES A TURN

COMPONENTS OF DIFFERENTIAL

- CROWN WHEEL /PINION (REAR AXLE RATIO)
- DIFFERENTIAL GEARS

DIFFERENTIAL

TORQUE FROM GEAR BOX

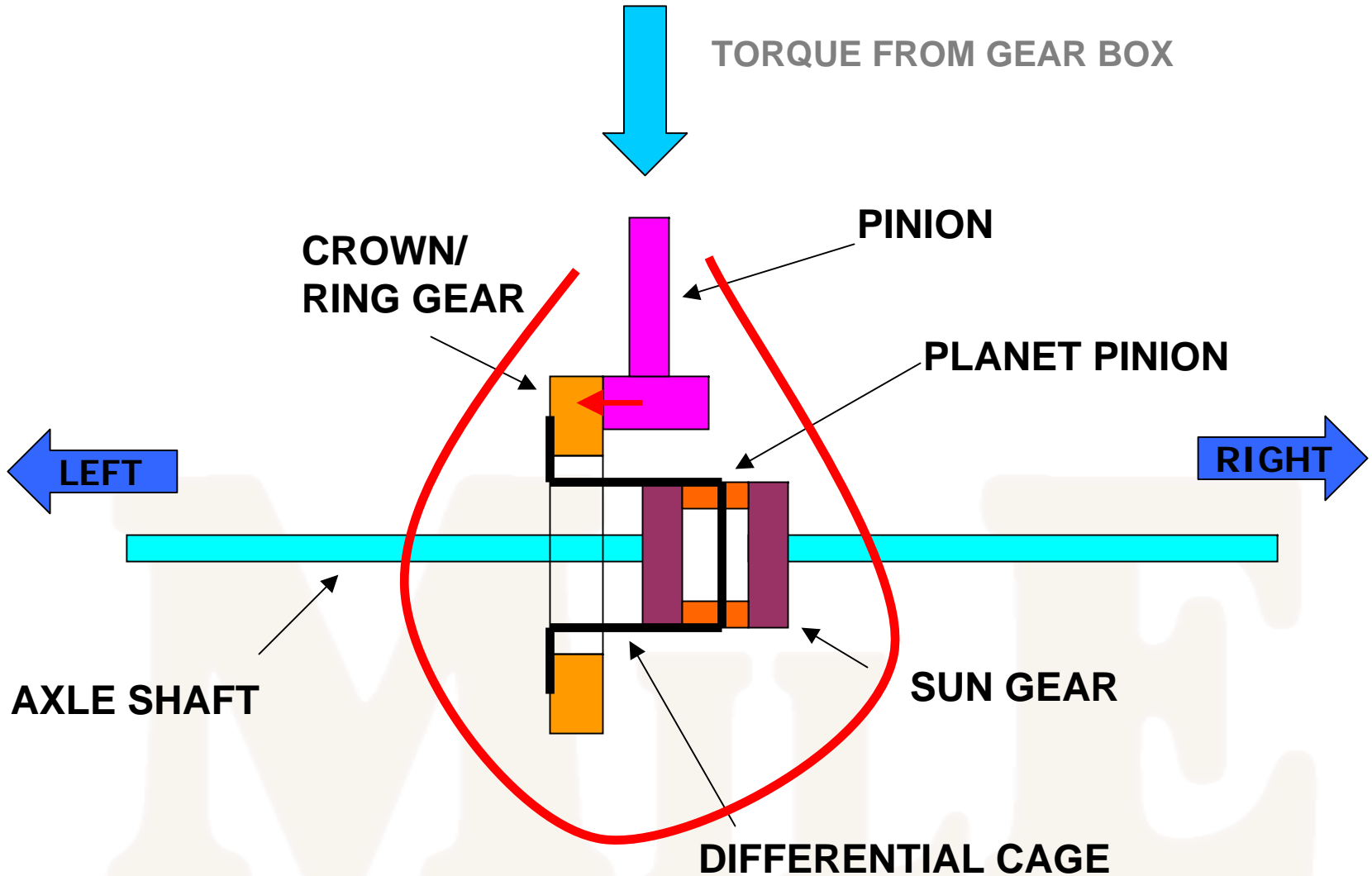

DIFFERENTIAL

1. CROWN WHEEL/PINION - Also known as rear axle ratio, is fixed gear reduction at the rear axle. Crown wheel/pinion receives the torque from gear box (through propeller shaft) , multiplies the torque and directs it to both wheels in a perpendicular direction, through the differential. Crown & Pinion pair is known as **Hypoid pair**.

2. DIFFERENTIAL MECHANISM - Equalises the torque between both wheels. Allows both wheels to rotate at different speeds to avoid tyre slippage during cornering. Due to the feature of “torque equalisation” , if one tyre is stuck in soft ground.mud, the other tyre will not rotate.

3. AXLE SHAFTS - Carries the torque from the differential to the wheels.

SYSTEMS IN AN AUTOMOBILE

A. POWER TRAIN SYSTEM

- **POWER PLANT (POWER GENERATION - ENGINE)**

- **ENGINE**
- **FUEL SYSTEM**
- **INTAKE SYSTEM**
- **EXHAUST SYSTEM**
- **COOLING SYSTEM**

- **DRIVE LINE (POWER TRANSMISSION)**

- **CLUTCH**
 - **GEAR BOX/TRANSMISSION**
 - **TRANSFER CASE**
 - **DIFFERENTIAL**
 - **WHEELS/TYRES**
- 

B. RUNNING SYSTEM

- **SUSPENSION**
- **STEERING**
- **BRAKING**

C. COMFORT SYSTEM

- **HVAC/AC/HEATER SYSTEM**
- **SEATING/UPHOLSTRY/FACIA/INSTRUMENTS**
- **AUDIO/VIDEO/GPS**

WHEELS

WHEELS **CARRY THE LOAD** OF THE VEHICLE & **TRANSMIT THE TORQUE** TO THE TYRES

WHEELS ARE SUPPORTED IN **WHEEL BEARINGS**

BASED ON WAY IN WHICH THE LOAD IS CARRIED AND THE TORQUE IS TRANSMITTED, THE AXLE CAN BE CLASSIFIED AS :

SEMI-FLOATING AXLE - In which the vehicle load as well as the torque are transmitted by the axle shaft

FULL FLOATING AXLE - In which the axle shaft only transmits the drive torque to the wheels. The vehicle load is taken up by the rear axle housing.

COMPONENTS OF WHEELS

- **AXLE SHAFT**
- **WHEEL SPINDLE**
- **WHEEL BEARINGS**

WHEELS

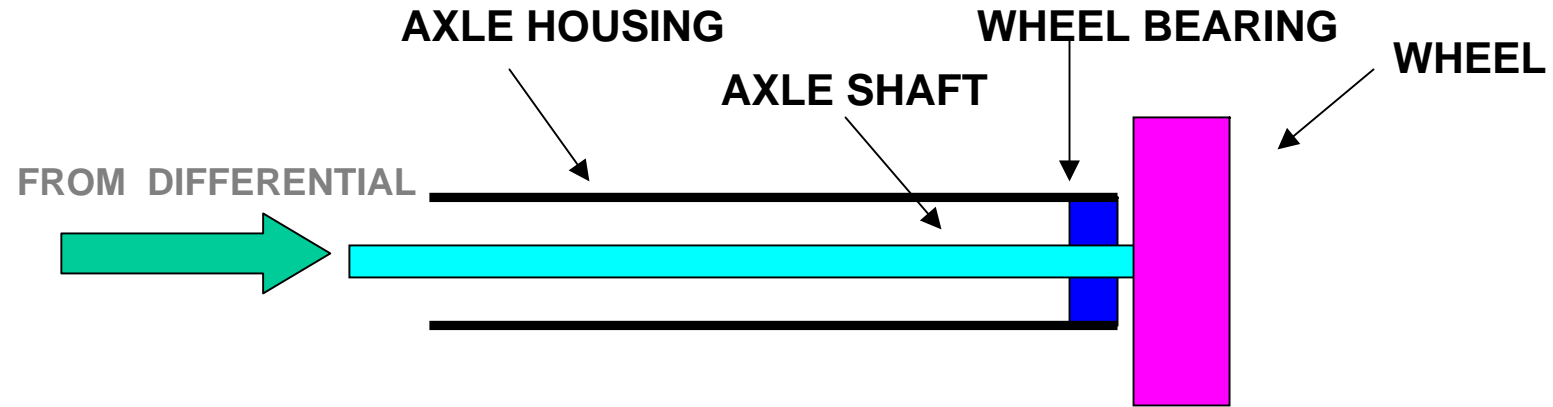

SEMI-FLOATING AXLE

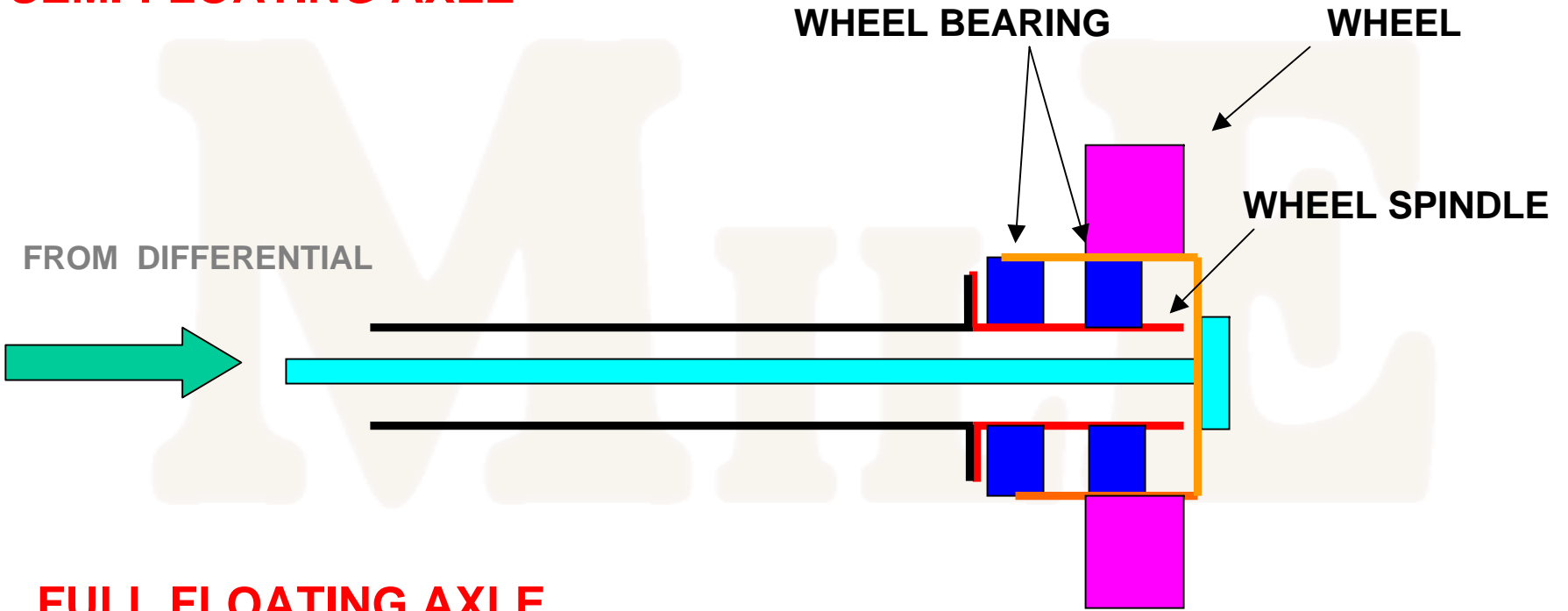

FULL FLOATING AXLE

WHEEL RIM

WHEEL RIMS ARE ATTACHED TO THE WHEEL AND CARRY THE TYRE & TUBE AT THE OTHER END.

WHEEL RIMS ARE SPECIFIED AS :

1. WHEEL RIM DIAMETER - The diameter of the wheel rim is specified in **inches** - 16", 15" etc

2. WHEEL RIM OFFSET - It is the difference between the wheel rim centre and the wheel rim mounting face

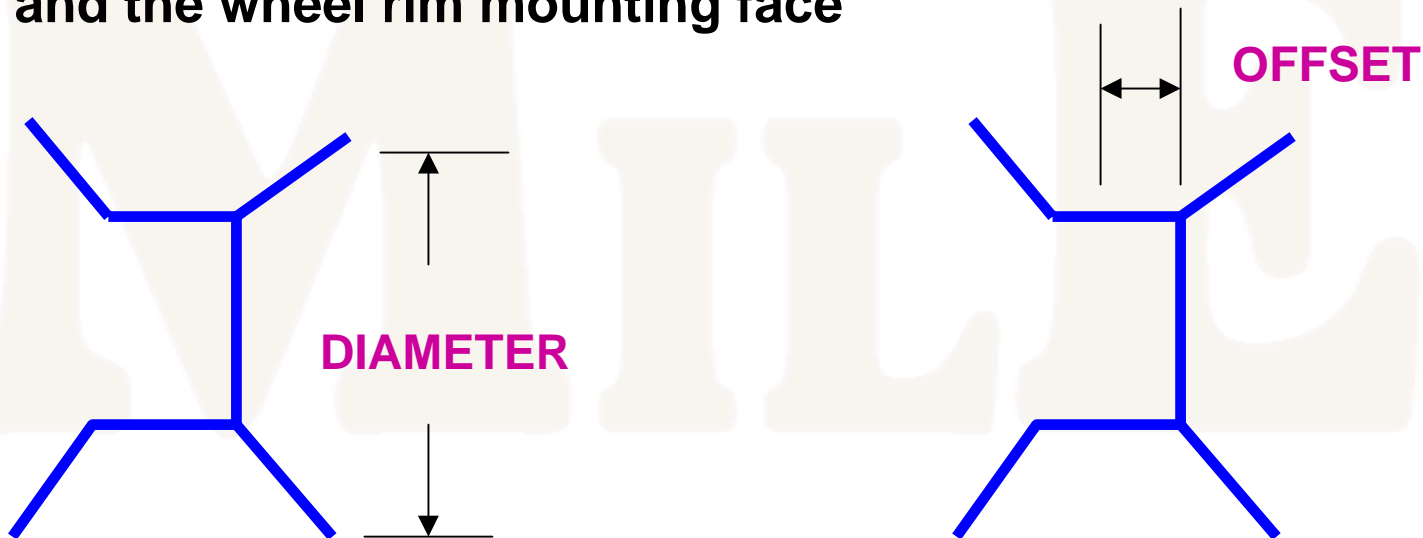

WHEEL RIM

WHEEL RIM SPECIFICATIONS

6J X 15



WHEEL RIM OFFSET



WHEEL RIM DIAMTER, in



TYRE

THE PURPOSE OF THE TYRE IS TO PROVIDE A FRICTIONAL INTERFACE WITH THE ROAD SO THAT THE DRIVE TORQUE CAN BE TRANSMITTED TO THE ROAD FOR VEHICLE MOTION.

TYRE ALSO SUPPORTS THE VEHICLE LOAD

TYRES ARE CLASSIFIED AS :

CROSS PLY TYRES - The inner plies run at an angle to the tyre centre line

RADIAL PLY TYRE - The inner plies run perpendicular to the tyre centre line. Radial tyres have low rolling resistance and hence the fuel efficiency of the vehicle improves. Radial tyres also provide softer ride due to the softer side walls.

TYRE

TYRE SPECIFICATIONS

$$\text{ASPECT RATIO} = \frac{\text{TYRE HEIGHT}}{\text{TYRE WIDTH}} \times 100$$

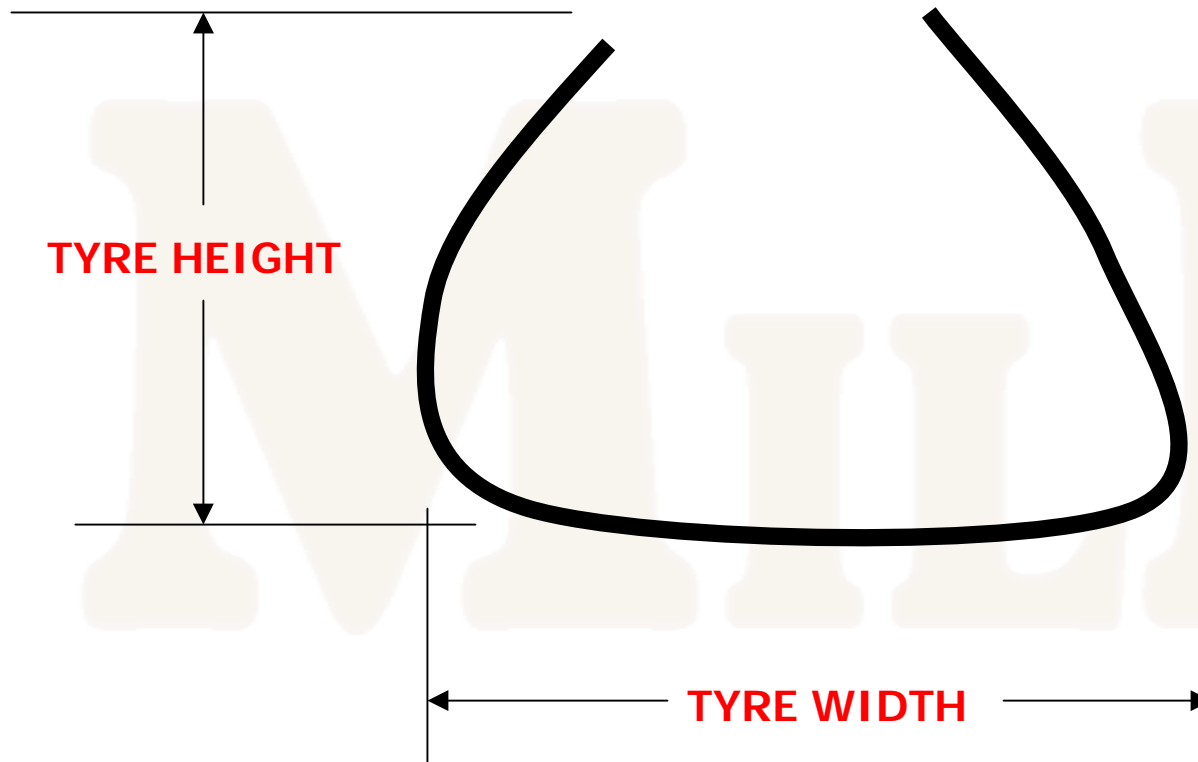

TYRE

TYRE SPECIFICATIONS

P 235/75 R 15



PASSENGER CAR



TYRE WIDTH, mm



ASPECT RATIO, %



RADIAL



WHEEL RIM DIAMETER, in

TYRE

TYRE SPECIFICATIONS

6.00 X 16 8 PR

TYRE WIDTH , **in**

WHEEL RIM DIAMTER, **in**

PLY RATING

SAMPLE LEAFLET

MARSHAL 2000

- REAR AXLE : FULL FLOATING, HYPOID TYPE
CAPACITY 1700 Kg, RATIO 4.27 : 1
- WHEELS : DISC TYPE, RIM SIZE 6J X 15
- TYRE : P215/75 R 15,RADIAL,

MILE

ANATOMY OF AN AUTOMOBILE

(REAR WHEEL DRIVE - 2WD)

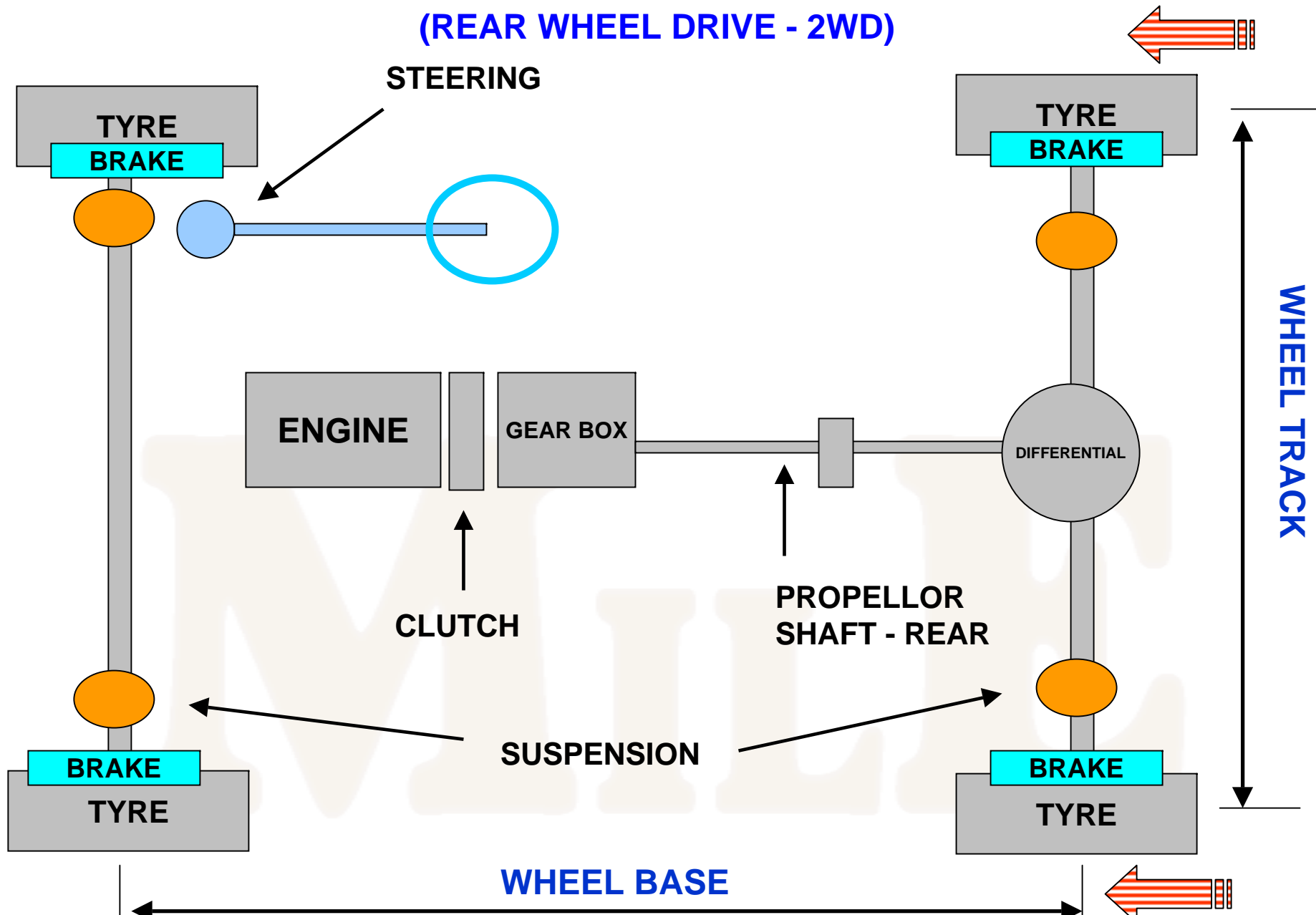

SYSTEMS IN AN AUTOMOBILE

A. POWER TRAIN SYSTEM

- **POWER PLANT (POWER GENERATION - ENGINE)**

- **ENGINE**
- **FUEL SYSTEM**
- **INTAKE SYSTEM**
- **EXHAUST SYSTEM**
- **COOLING SYSTEM**

- **DRIVE LINE (POWER TRANSMISSION)**

- **CLUTCH**
- **GEAR BOX/TRANSMISSION**
- **TRANSFER CASE**
- **DIFFERENTIAL**
- **WHEELS/TYRES**

B. RUNNING SYSTEM

- **SUSPENSION**
- **STEERING**
- **BRAKING**

C. COMFORT SYSTEM

- **HVAC/AC/HEATER SYSTEM**
- **SEATING/UPHOLSTRY/FACIA/INSTRUMENTS**
- **AUDIO/VIDEO/GPS**



RUNNING SYSTEM

- **POWER PLANT GENERATES** THE POWER/TORQUE
- **DRIVELINE MODIFIES & TRANSMITS** THE TORQUE

THE RUNNING SYSTEM **CONTROLS** THE VEHICLE

RUNNING SYSTEM CONSISTS OF

- SUSPENSION** - Provides a comfortable ride
- BRAKES** - Allows to slow down the vehicle
- STEERING** - Allows to change direction of the vehicle

SYSTEMS IN AN AUTOMOBILE

A. POWER TRAIN SYSTEM

- POWER PLANT (POWER GENERATION - ENGINE)

- ENGINE
- FUEL SYSTEM
- INTAKE SYSTEM
- EXHAUST SYSTEM
- COOLING SYSTEM

- DRIVE LINE (POWER TRANSMISSION)

- CLUTCH
- GEAR BOX/TRANSMISSION
- TRANSFER CASE
- DIFFERENTIAL
- WHEELS/TYRES

B. RUNNING SYSTEM

- SUSPENSION
- STEERING
- BRAKING



C. COMFORT SYSTEM

- HVAC/AC/HEATER SYSTEM
- SEATING/UPHOLSTRY/FACIA/INSTRUMENTS
- AUDIO/VIDEO/GPS

SUSPENSION

SUSPENSION **ABSORBS ROAD SHOCKS** AND PROVIDES COMFORTABLE RIDE FOR THE PASSENGERS

SUSPENSION CAN BE CLASSIFIED AS :

RIGID SUSPENSION
INDEPENDENT SUSPENSION

COMPONENTS OF SUSPENSION

- SPRINGS
- SHOCK ABSORBER
- STABILIZER BAR

SUSPENSION

1. SPRINGS - Springs are mounted at each wheel and they absorb the road shocks created when the vehicle travels over potholes or speed breakers.

Springs are of various types, namely :

Leaf springs - Leaf springs are multi-layered steel plates clamped together.

Coil springs - Coil springs are made of thick steel wires wound in a spring form - **Scorpio Front, Bolero Front**

Torsion bar - Torsion bar are long steel rods of either circular or square cross section. The springing action is generated by the torsional forces when the torsion bar is twisted - **Scorpio 4WD Front**

SUSPENSION

2. SHOCK ABSORBERS - The springs absorb road shocks. While absorbing the shock, the spring is compressed. However, due to the characteristic of springs, the absorbed shock will be released immediately with the rebound of the spring. Hence, the vehicle will start oscillating after encountering a road irregularity.

The purpose of the shock absorber is to absorb the shocks when the spring starts oscillating, thus providing a smooth ride.

Shock absorbers are of **Hydraulic, double acting type** or **Gas filled**

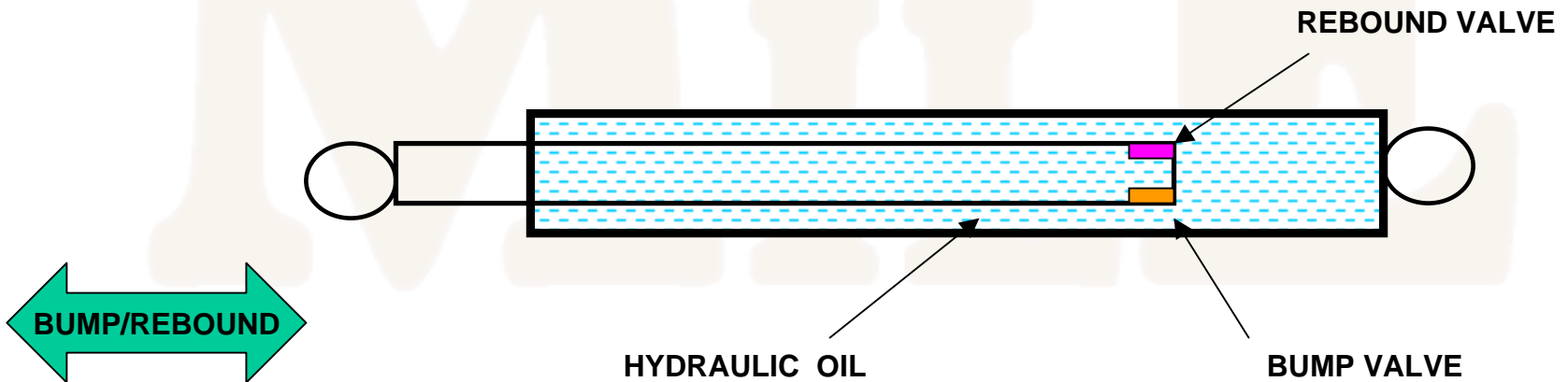

SUSPENSION

3. STABILIZER BAR - Stabilizer bars are fitted on the axles to reduce the amount of body roll, when the vehicle is cornered. Stabilizers bar acts as torsion bars and twist , restricting the excessive body roll.

MILE

SUSPENSION

TYPES OF SUSPENSIONS

SUSPENSION TYPES CAN BE BROADLY CLASSIFIED AS :

RIGID SUSPENSION - In rigid suspension both the wheels in an axle are connected by a rigid beam or a tube. Road irregularities encountered by one wheel is partially passed on to the other wheel

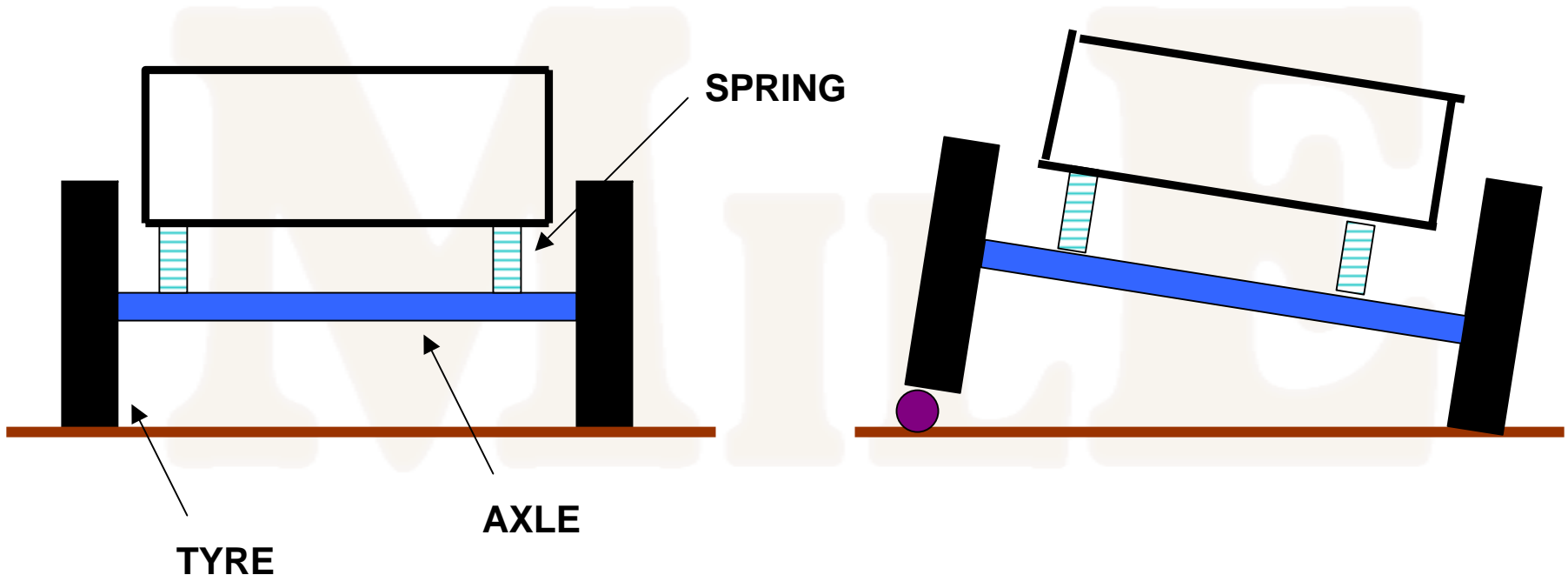

SUSPENSION

TYPES OF SUSPENSIONS

INDEPENDENT SUSPENSION - In independent suspension, each wheel is mounted separately. Road irregularities encountered by one wheel is absorbed by that wheel only.

IFS - Independent Front Suspension - **Bolero , Scorpio**

IRS - Independent Rear Suspension

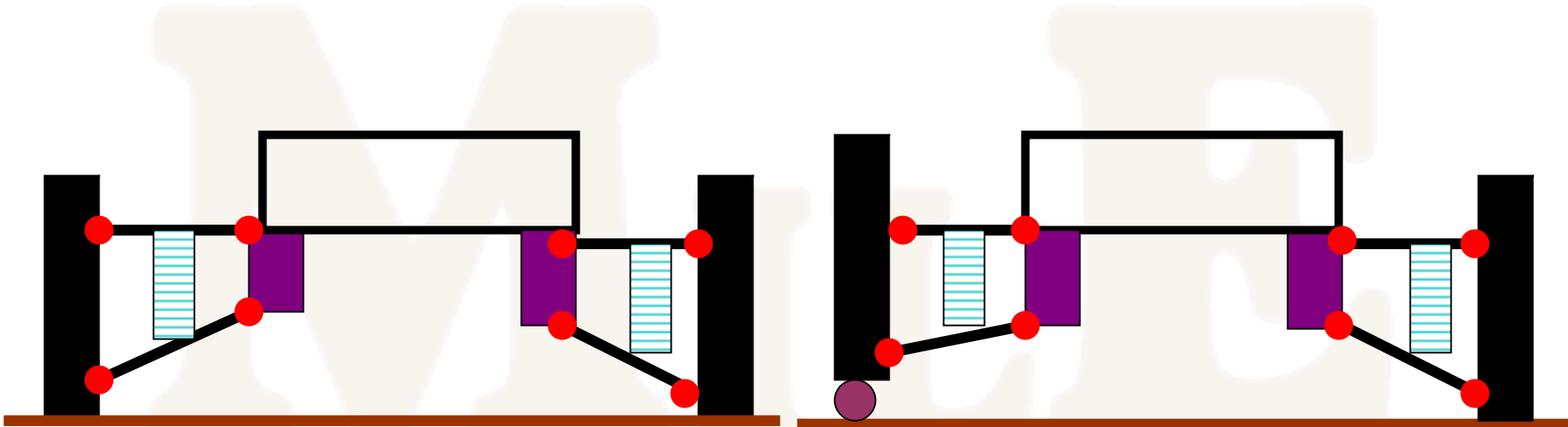



Suspension4.exe

SAMPLE LEAFLET

MARSHAL 2000

SUSPENSION FRONT : SEMI-ELLIPTICAL LEAF SPRING
REAR : SEMI-ELLIPTICAL LEAF SPRING

**: HYDRAULIC , DOUBLE ACTING, TELESCOPIC
SHOCK ABSORBERS**

FRONT : STABILIZER BAR

MILLE

SYSTEMS IN AN AUTOMOBILE

A. POWER TRAIN SYSTEM

- **POWER PLANT (POWER GENERATION - ENGINE)**

- **ENGINE**
- **FUEL SYSTEM**
- **INTAKE SYSTEM**
- **EXHAUST SYSTEM**
- **COOLING SYSTEM**

- **DRIVE LINE (POWER TRANSMISSION)**

- **CLUTCH**
- **GEAR BOX/TRANSMISSION**
- **TRANSFER CASE**
- **DIFFERENTIAL**
- **WHEELS/TYRES**

B. RUNNING SYSTEM

- **SUSPENSION**
- **STEERING**
- **BRAKING**



C. COMFORT SYSTEM

- **HVAC/AC/HEATER SYSTEM**
- **SEATING/UPHOLSTRY/FACIA/INSTRUMENTS**
- **AUDIO/VIDEO/GPS**

STEERING

THE PURPOSE OF THE STEERING IS TO **CHANGE THE DIRECTION OF VEHICLE** MOVEMENT, AS DESIRED BY THE DRIVER.

STEERING SYSTEMS CAN BE :

MANUAL STEERING

POWER ASSISTED STEERING

COMPONENTS OF STEERING SYSTEM

- STEERING GEAR BOX
- STEERING WHEEL
- STEERING INNER/OUTER COLUMNS
- TIE RODS
- POWER STEERING PUMP
- POWER STEERING RESERVOIR
- POWER STEERING HOSES/PIPES

STEERING

MANUAL STEERING - In which, the driver's muscular energy is directly used in steering the wheels of the vehicle.

POWER ASSISTED STEERING - In which, the driver is aided by an external power assistance, so that the efforts required at the steering wheel is lower.

In case of failure of the source of power, the steering system reverts to manual steering.

Power source for the steering can be :

1. Hydraulic power - Hydraulic pressure generated by a power steering pump, driven by the engine.

2. Electric power - An electric motor driven by the vehicle electrical system and controlled by a an ECU. Also known as **Electronic Power Steering (EPS)**

STEERING

MANUAL STEERING

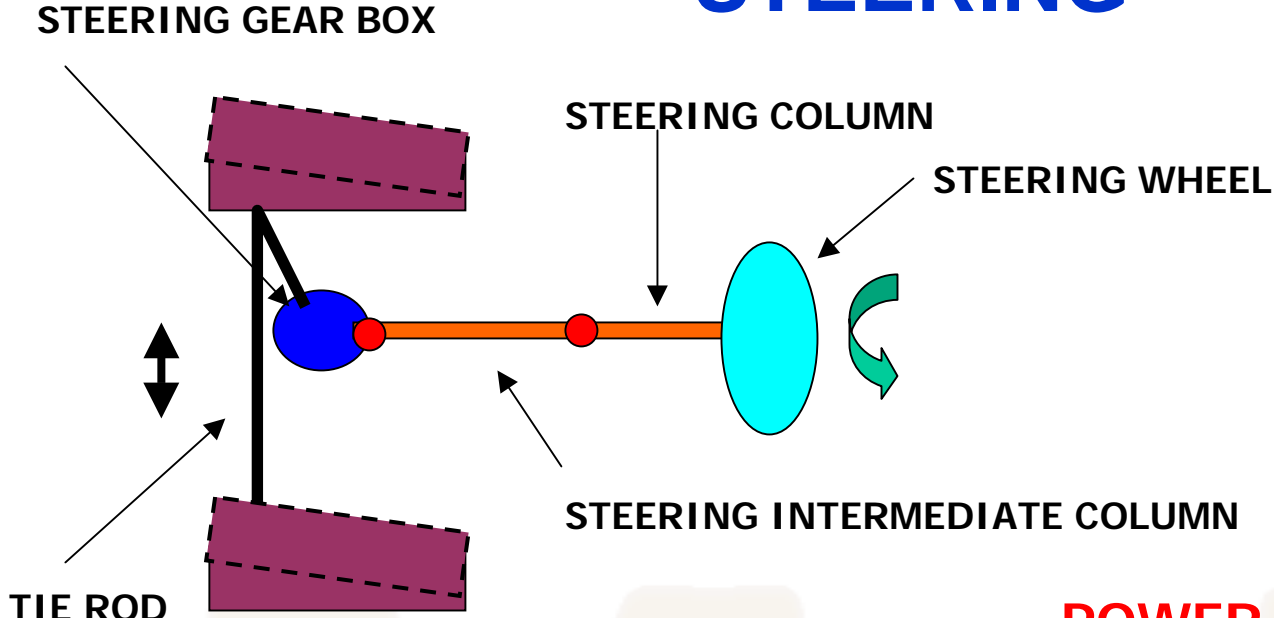

POWER ASSISTED STEERING (HYDRAULIC)

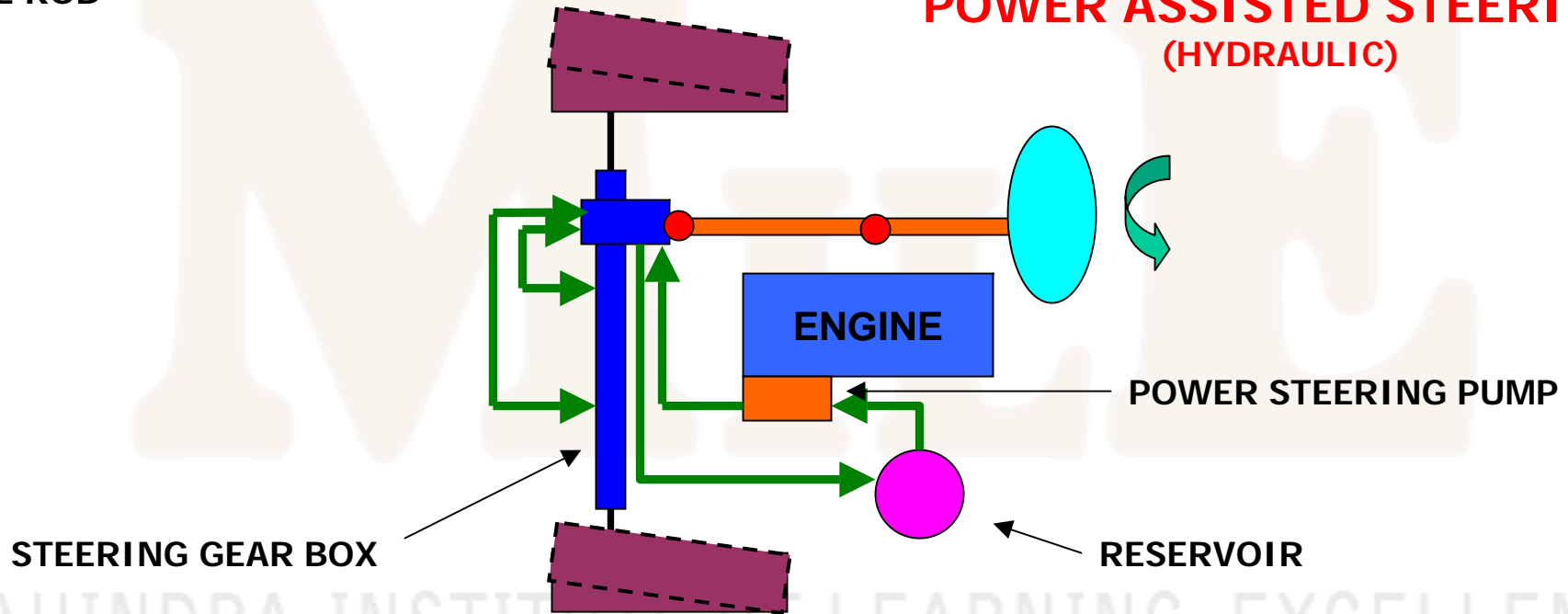

STEERING

1. STEERING GEAR BOX - Steering gear box converts driver's effort at steering wheel (Rotary) to a linear movement at tie rods. The tie rods are connected to the wheels which turn either left or right.

Various types of steering gear box designs are available. The various designs are based on the type of gear reduction used inside the steering gear box

Worm & roller

Re-circulating Ball type (RCBT)

Rack & pinion type - Scorpio , Bolero

Steering gear can be either **Manual or Power assisted**

STEERING

2. STEERING WHEEL - Transmits the driver's hand effort to the steering gear box.

3. STEERING COLUMNS - Link between the steering wheel and the steering gear box.

4. TIE-RODS - The connection between the steering gear box and the wheels.

5 .POWER STEERING RESERVOIR - Holds the hydraulic steering fluid and supplies the same to Steering pump , as and when required.

MILLE

STEERING

6. POWER STEERING PUMP - Driven by engine. Generates hydraulic pressure and directs it to the steering gear box.

Since the power steering pump is driven by the engine, the pump speed increases as the engine speed increases. Increase in the engine speed generates more pressure of the power steering fluid. Due to higher steering fluid pressures, the amount of assistance also increases at higher engine/vehicle speeds. This is not desirable as the steering becomes softer and softer as the vehicle speed increases, leading to difficulty in controlling the vehicle.

SPEED SENSITIVE POWER STEERING - In which a special valve reduces the steering fluid pressure as the engine speed increases. This is known as speed sensitive power steering.

SAMPLE LEAFLET

MARSHAL 2000

STEERING

: RECIRCULATING BALL TYPE

MILLE

SYSTEMS IN AN AUTOMOBILE

A. POWER TRAIN SYSTEM

- **POWER PLANT (POWER GENERATION - ENGINE)**

- **ENGINE**
- **FUEL SYSTEM**
- **INTAKE SYSTEM**
- **EXHAUST SYSTEM**
- **COOLING SYSTEM**

- **DRIVE LINE (POWER TRANSMISSION)**

- **CLUTCH**
- **GEAR BOX/TRANSMISSION**
- **TRANSFER CASE**
- **DIFFERENTIAL**
- **WHEELS/TYRES**

B. RUNNING SYSTEM

- **SUSPENSION**
- **STEERING**
- **BRAKING**



C. COMFORT SYSTEM

- **HVAC/AC/HEATER SYSTEM**
- **SEATING/UPHOLSTRY/FACIA/INSTRUMENTS**
- **AUDIO/VIDEO/GPS**

BRAKES

THE PURPOSE OF THE BRAKES IS TO **SLOW DOWN OR STOP THE VEHICLE** AS DESIRED BY THE DRIVER

BRAKE SYSTEMS CAN BE CLASSIFIED AS :

HYDRAULIC BRAKES

POWER ASSISTED BRAKES

- **VACUUM ASSISTED**
- **COMPRESSED AIR ASSISTED**

AIR BRAKES (Used in heavy commercial vehicles)

COMPONENTS OF THE BRAKING SYSTEM

- **TANDEM MASTER CYLINDER**
- **WHEEL BRAKES**
- **BRAKE BOOSTER**
- **VACUUM PUMP**
- **PRESSURE CONTROL VALVES (G VALVE/LSPV)**
- **BRAKE FLUID RESERVOIR**

BRAKES

MANUAL HYDRAULIC BRAKE

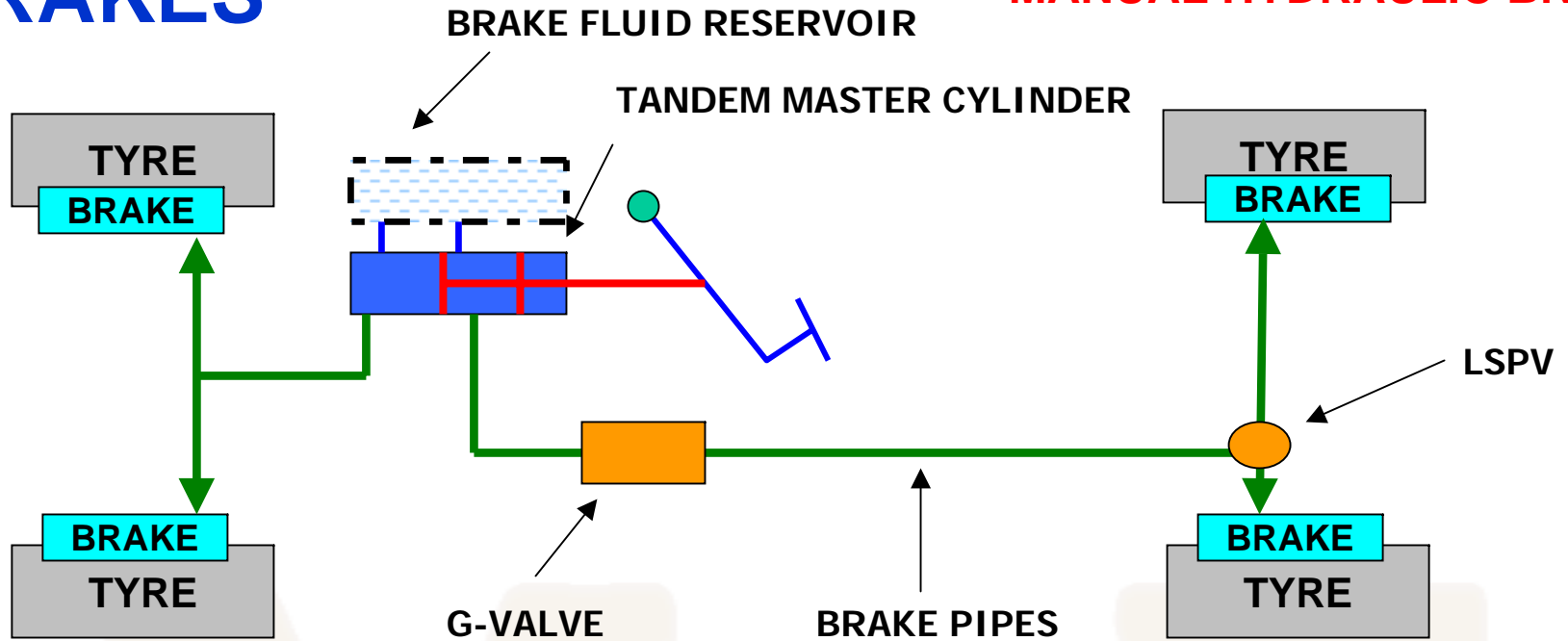

EITHER G-VALVE OR LSPV IS FITTED

BRAKES

BRAKE SPLIT

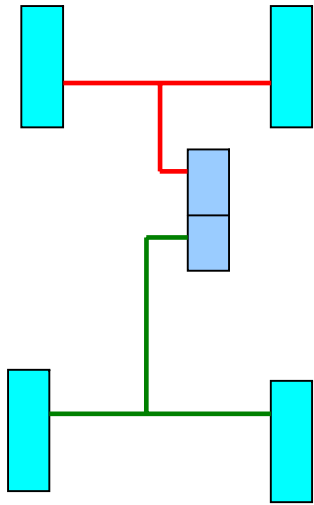

FRONT/BACK SPLIT

- ALL M&M MODELS

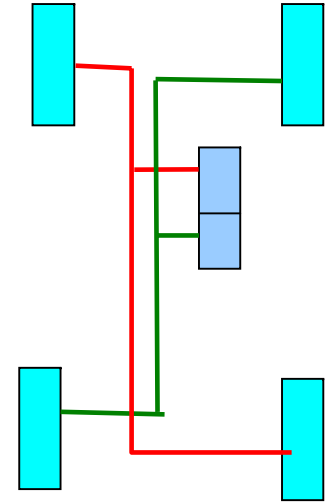

X- SPLIT

BRAKES

POWER ASSISTED BRAKE (VACUUM)

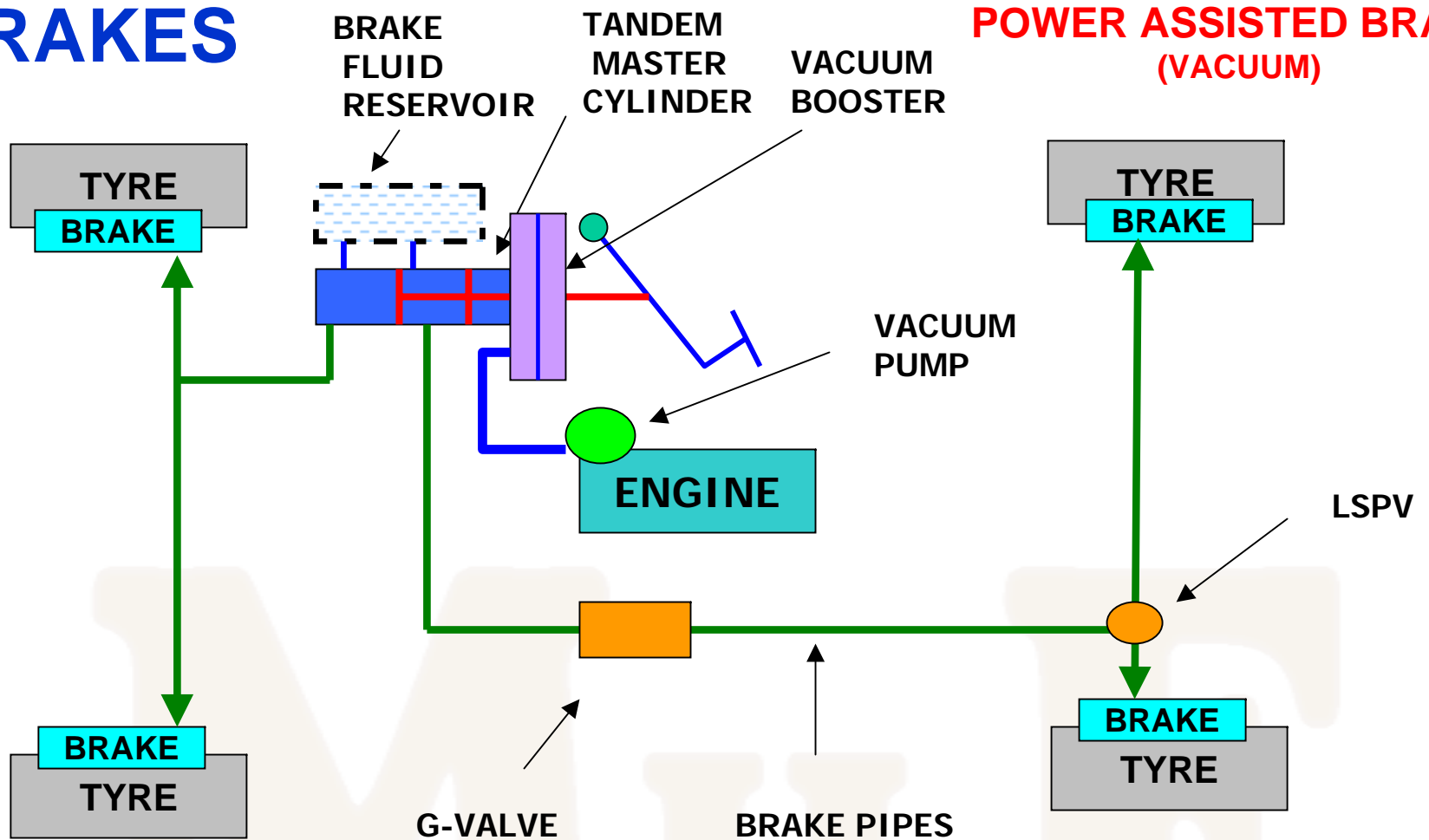

BRAKES

1. TANDEM MASTER CYLINDER - Converts driver's foot effort to hydraulic pressure and transmits the pressure to wheel cylinders.

The tandem master cylinder has 2 compartments for safety . Each compartment is connected separately and independently to either front or rear wheel brakes. Failure of one circuit (leakage) will lead to brake failure in that particular axle. The vehicle can be brought to stop with the working brakes in the other axle, with higher pedal effort.

MILE

BRAKES

2. WHEEL BRAKES - Wheel brakes are fitted on each wheel. Wheel brakes can be classified as **Drum brakes & Disc brakes**

DRUM BRAKES - Where a set of **brake liners** expand against a **brake drum** leading to braking of the vehicle. The brake liners are operated by a **wheel cylinder** which receives hydraulic pressure from the tandem master cylinder.

Drum brakes are normally fitted on Front & Rear brakes

Drum brakes can be further classified as :

Simplex(HNSS) - Hydraulic Normal Shoe Sliding - Fitted at Rear/Front

Duplex (HLSS) - Hydraulic Leading Shoe Sliding - Fitted at Front

Duo-Duplex -

BRAKES

DRUM BRAKES

BRAKE FLUID FROM MASTER CYLINDER

BRAKE FLUID FROM MASTER CYLINDER

WHEEL CYLINDER

BRAKE LINER

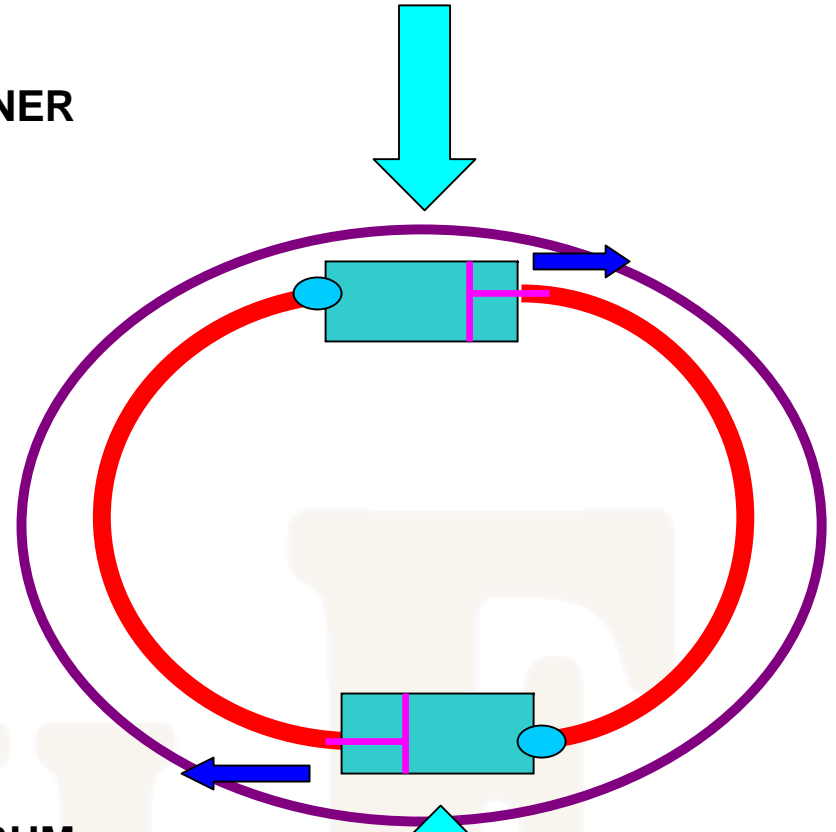
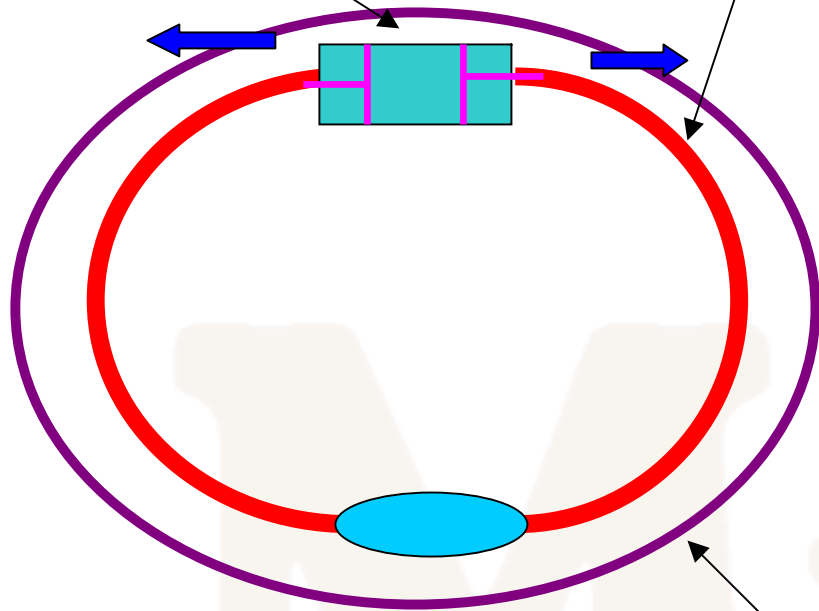

BRAKE DRUM

BRAKE FLUID FROM MASTER CYLINDER

SIMPLEX

- REAR BRAKE OF ALL MODELS

DUPLEX

- FRONT BRAKE OF ALL MODELS
(Except disc brake models)

BRAKES

DRUM BRAKES

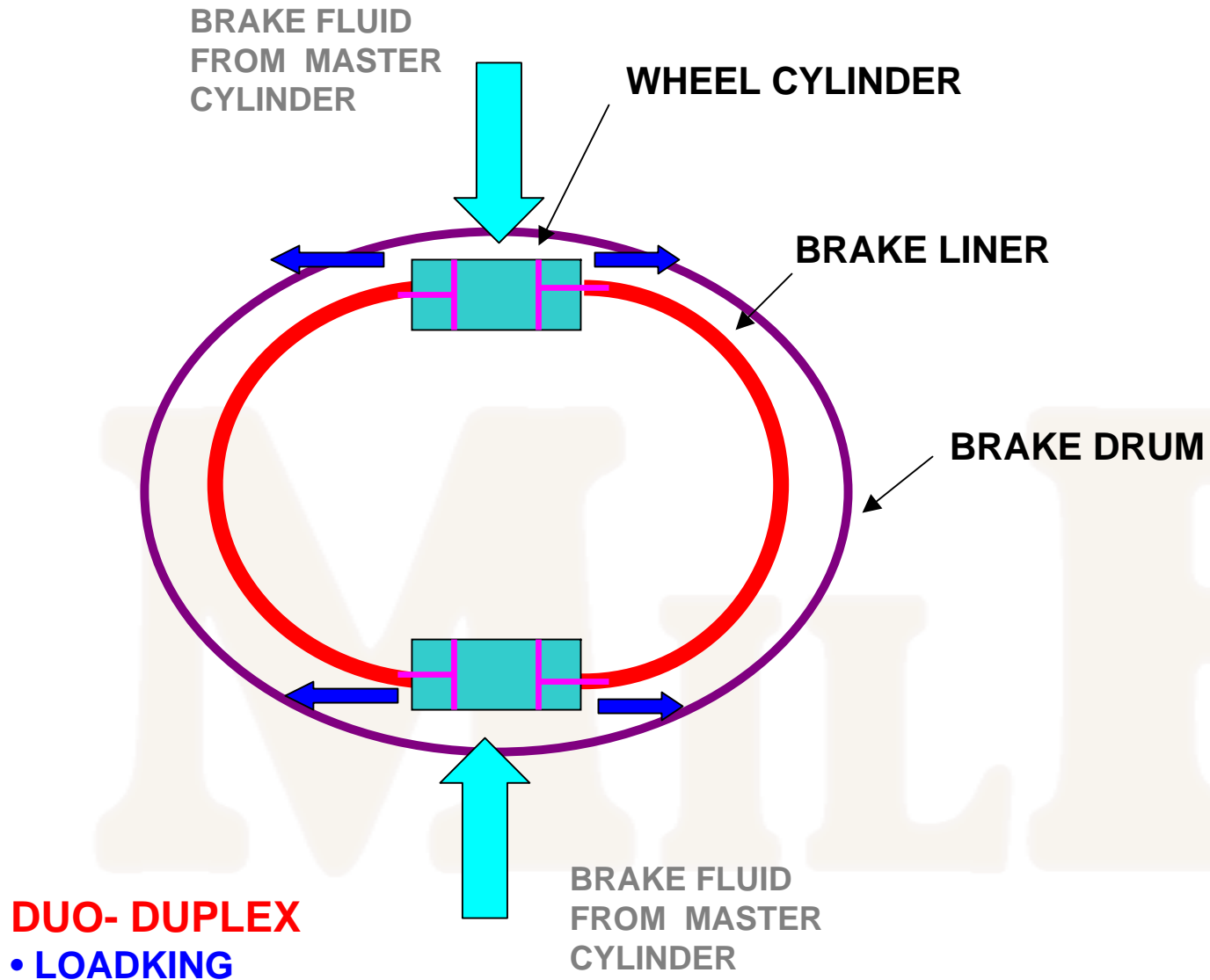

BRAKES

DISC BRAKES - Where a set of **brake pads** expand against a **brake disc** leading to braking of the vehicle. The brake liners are operated by a **wheel cylinder** which receives hydraulic pressure from the tandem master cylinder.

Disc brakes are normally fitted on Front brakes

Disc brakes can be further classified as :

Fixed Caliper - Where there are separate wheel cylinders each for inner & outer brake pad. (used in earth moving equipment)

Floating Caliper - Where there is only inner pad is moved by the wheel cylinder , the outer pad is moved by the caliper.

Floating caliper brakes can be further classified as :

Single pot - Where one wheel cylinder operates the inner pad

Twin pot - Where two wheel cylinders operates the inner pad

BRAKES

DISC BRAKES - FLOATING CALIPER - SINGLE POT

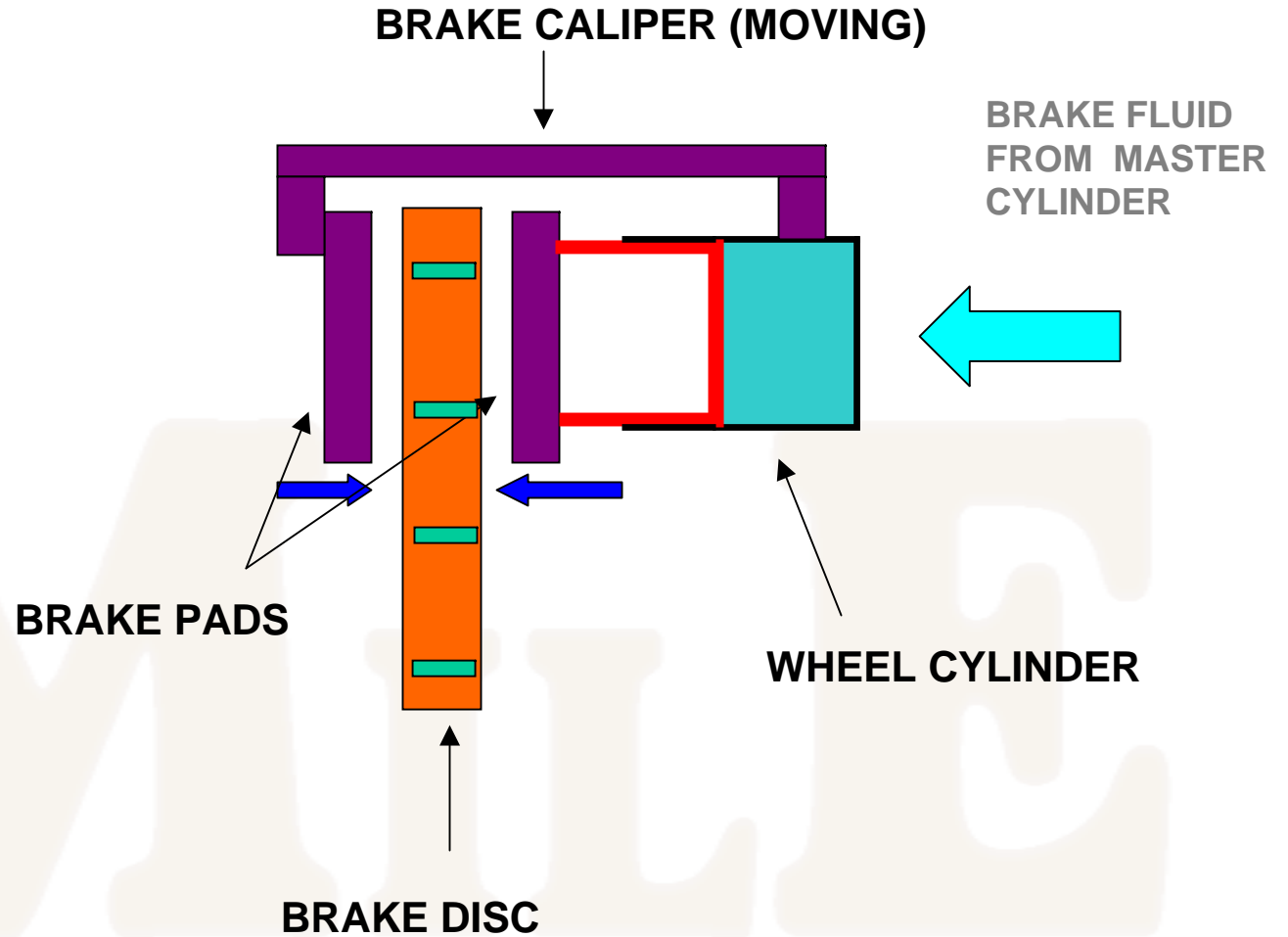

BRAKES

DISC BRAKES - FLOATING CALIPER - TWIN POT

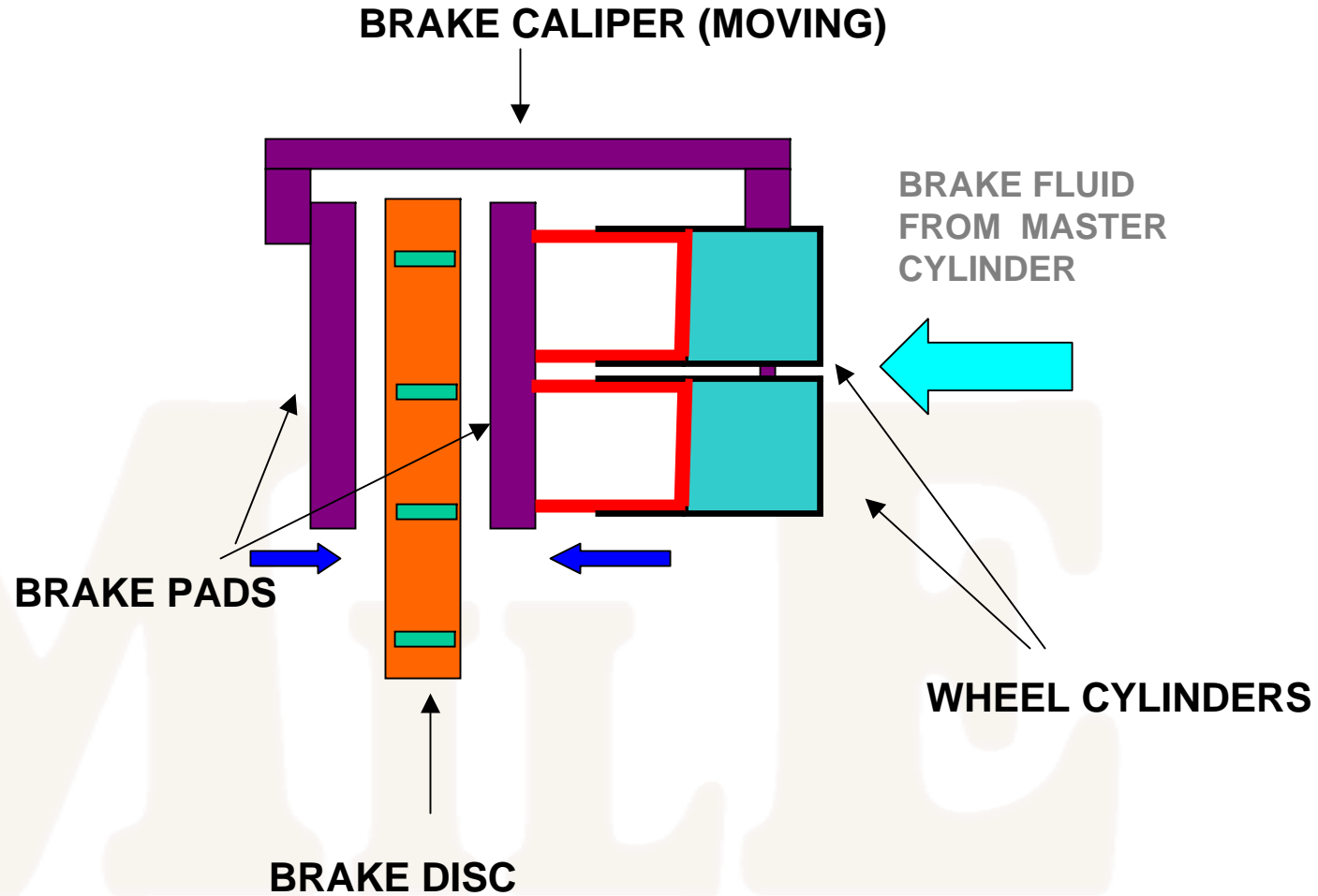

BRAKES

DISC BRAKES - FIXED CALIPER

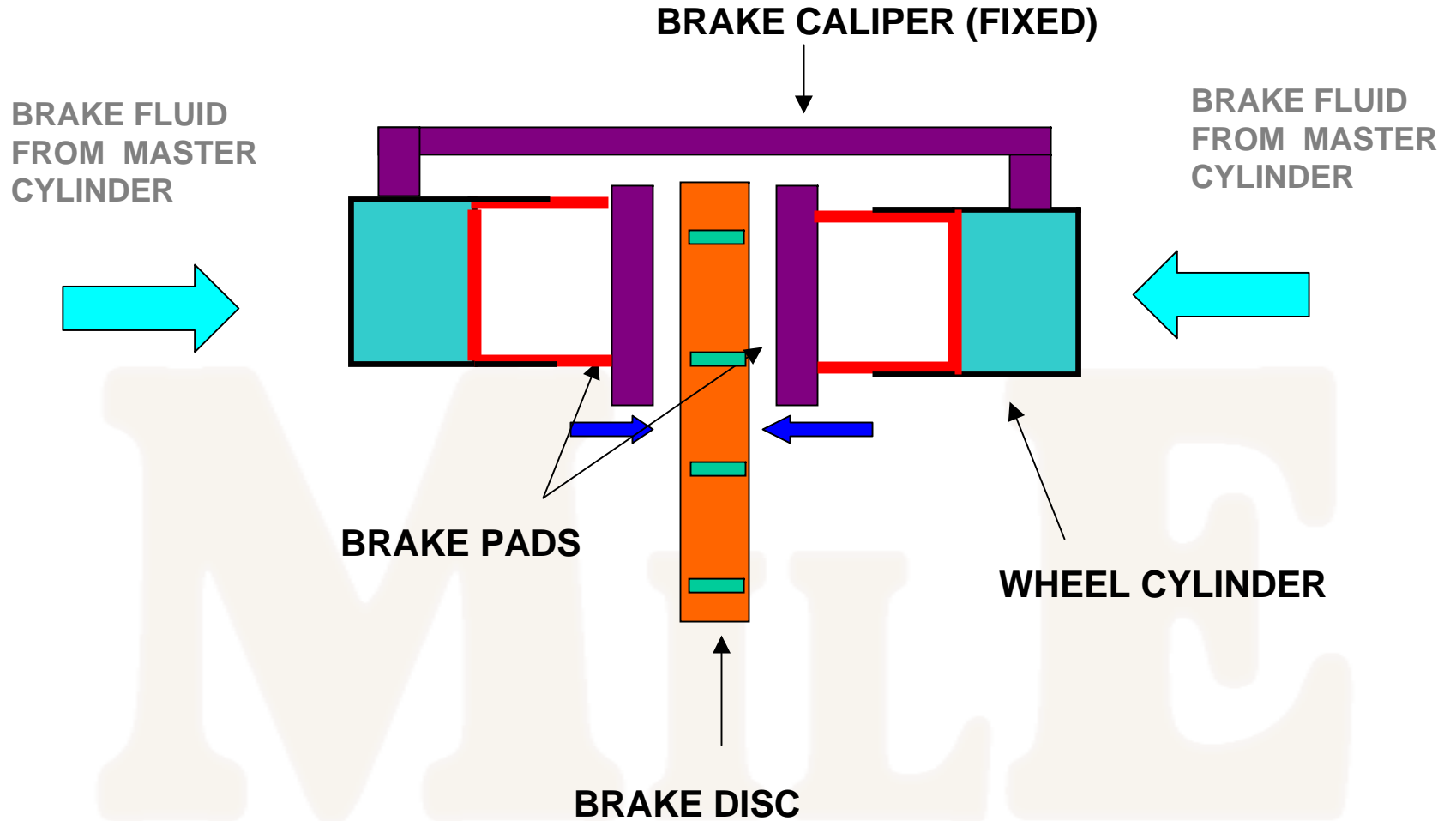

BRAKES

3. BRAKE BOOSTER - Also known as **Brake Servo**. Brake booster is fitted between the brake pedal and the tandem master cylinder. Brake booster supplies additional effort to the tandem master cylinder as soon as the brake pedal is pressed by the driver. The additional effort is derived from the vacuum generated by the vacuum pump. Brake pedal efforts are lower when equipped with brake booster.

Brake boosters are specified by the diameter of the diaphragm - 9” or 10”

In case of failure of the brake booster or loss of vacuum, the braking system reverts to manual system. More effort will be required to stop the vehicle.

TANDEM BOOSTER - Tandem boosters are 2 boosters of different sizes sandwiched in to one housing.

BRAKES

BOOSTER

BRAKE RELEASED

BRAKE PRESSED

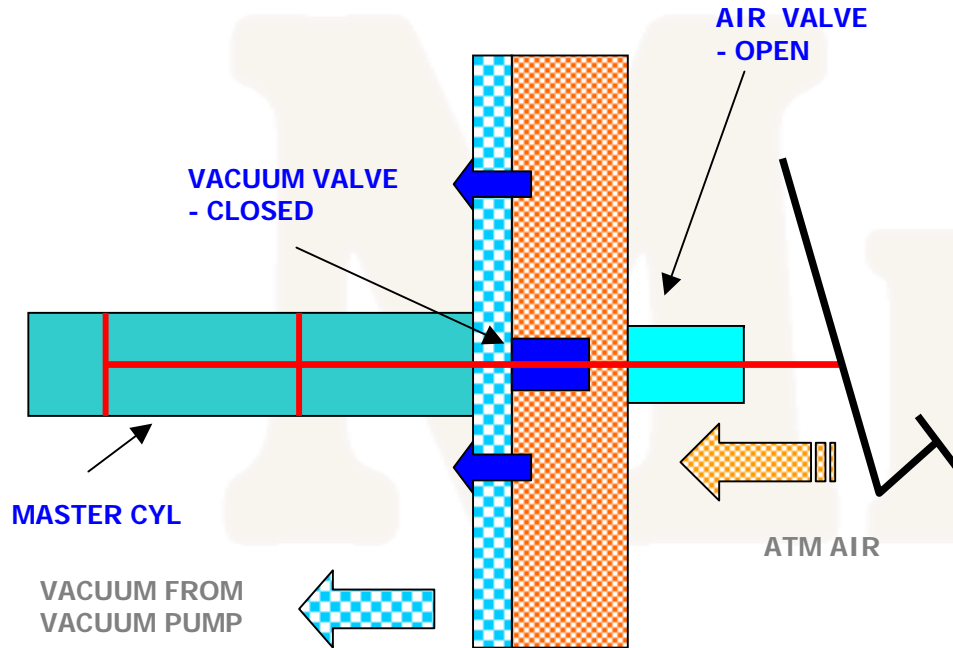
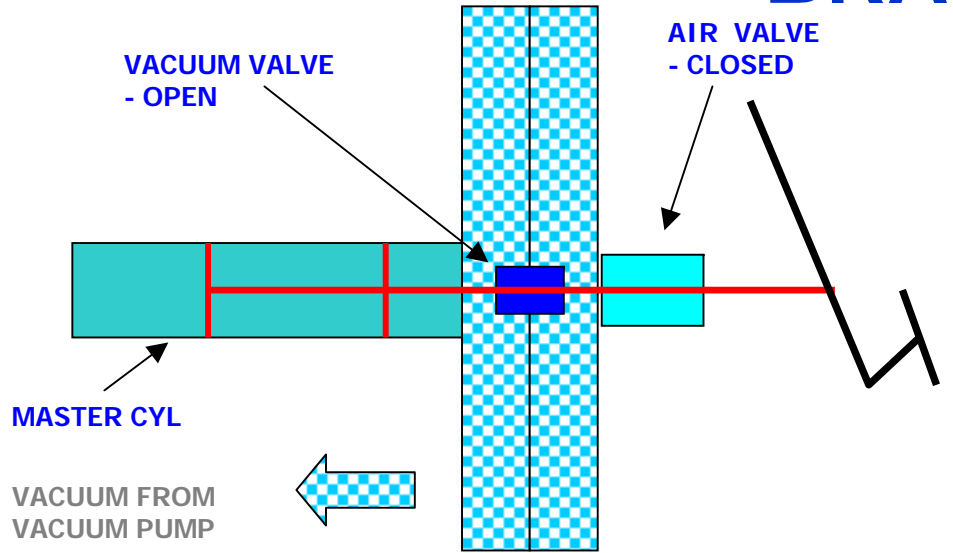

BRAKES

TANDEM BOOSTER

BRAKE RELEASED

ATM AIR

BRAKE PRESSED

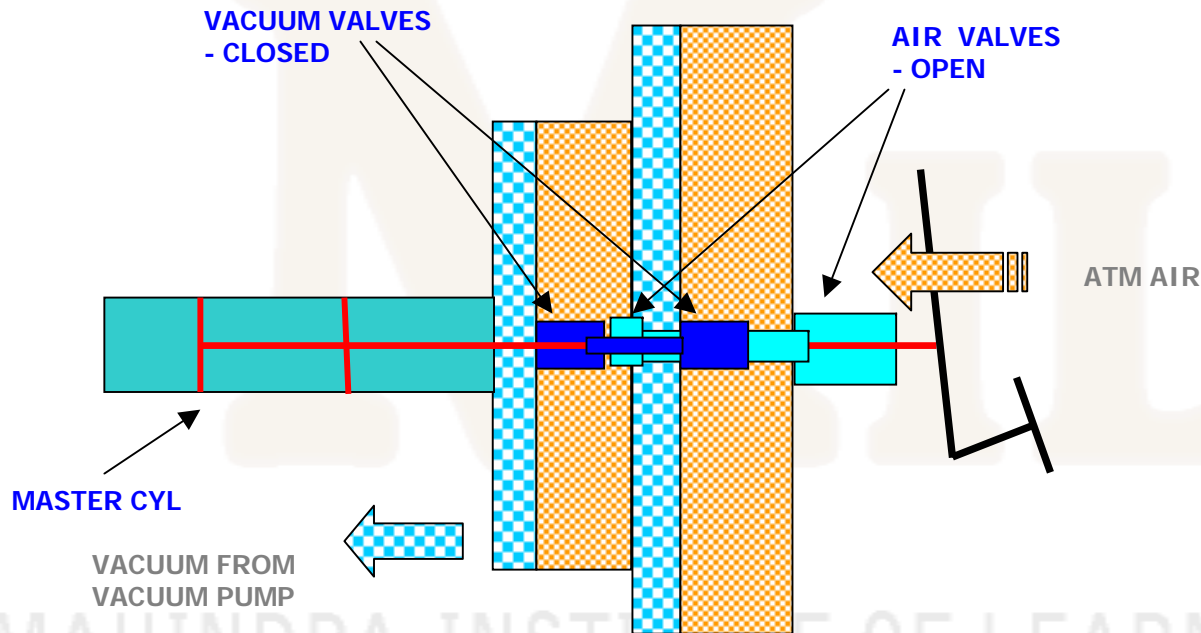
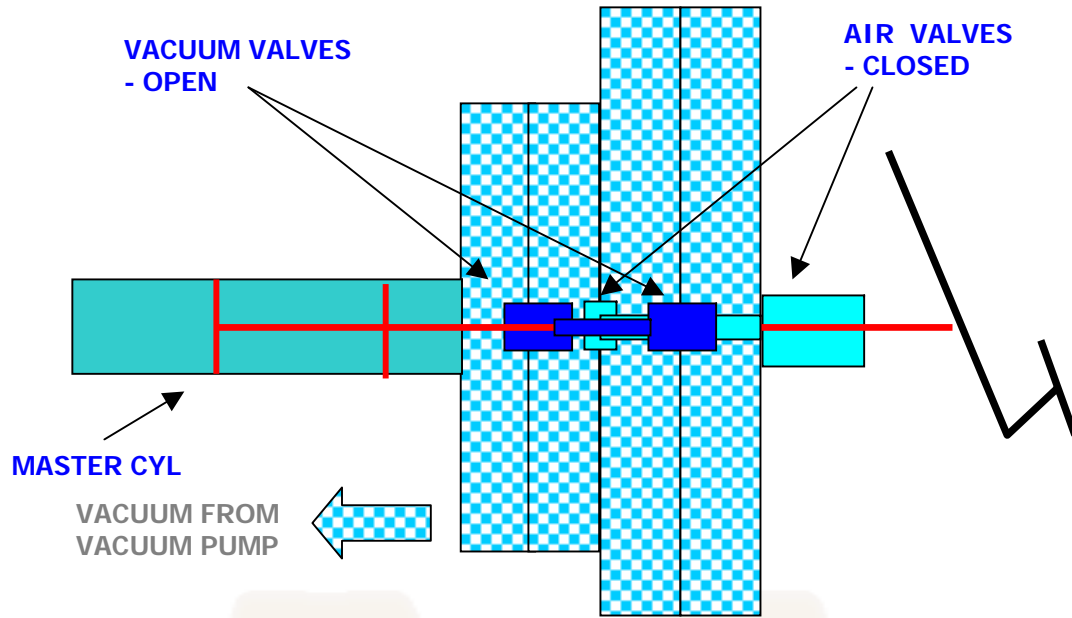

BRAKES

4. PRESSURE CONTROL VALVES - Pressure control valves **modify the brake fluid pressure to the rear braking circuit**, under certain conditions to avoid rear wheel locking.

When a vehicle is braked at high speeds, weight transfer happens. The vehicle weight shifts to the front axle. There will be relatively very less weight in the rear axles. The brake fluid pressure is same for both front & rear axles. This will lead to “Rear Wheel Lock” condition. A locked rear wheel will lead to vehicle instability and skidding/Tail swing.

Pressure control valves reduce the brake fluid pressure to the rear circuit , under these conditions. Pressure control valves are classified as :

PCRV - Pressure Conscious Regulating Valve

DCRV - Deceleration Conscious Regulating Valve - **Bolero (G-valve)**

LCRV - Load Conscious Regulating Valve - **Scorpio (LSPV)**

BRAKES

G-VALVE - G-valve is a deceleration conscious pressure regulating valve, fitted on the rear brake circuit. When the vehicle is braked hard, the g-level of the deceleration is sensed by a steel ball, which rolls forward and partially blocks the brake fluid to the rear brakes.

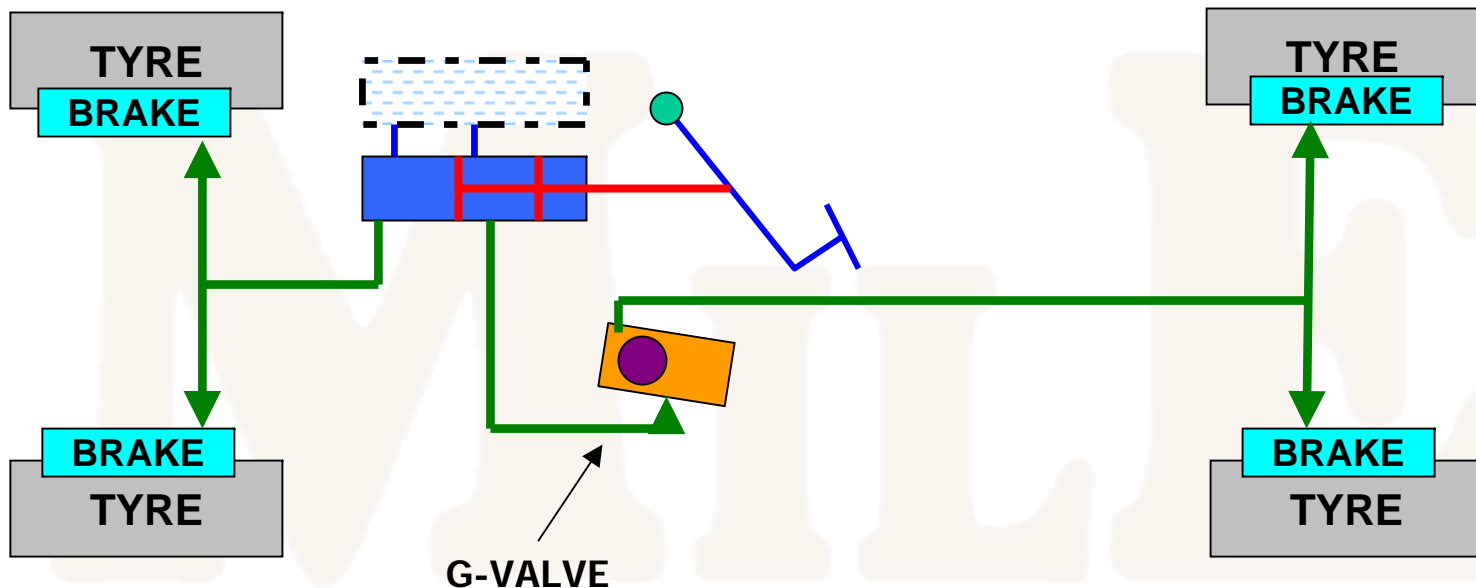

G-Valves are fitted at a specified angle in direction of vehicle motion

BRAKES

LCRV (Load Conscious Regulating Valve) - Also known as **LSPV (Load Sensitive Pressure Valve)**. LCRV detects the load on the vehicle and accordingly regulates the brake fluid pressure to the rear brakes.

Load (fully laden or unladen) is detected by height difference between the rear axle and the body, using levers or springs.

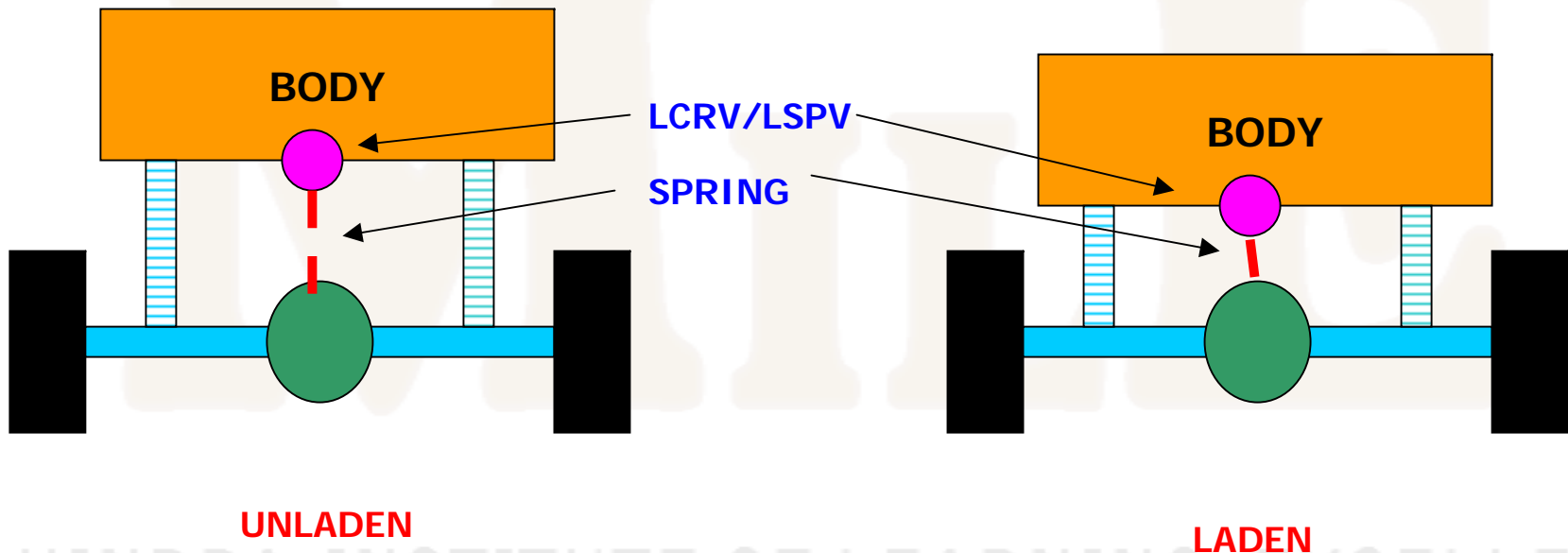

BRAKES

5. VACUUM PUMP - Vacuum pump generates vacuum for the brake booster. Vacuum pumps are mounted on the rear side of the alternator and are generally driven by the engine by a belt.

Failure of the belt will lead to vacuum pump stopping functioning leading to loss of vacuum to the booster and hard brakes.

6. BRAKE FLUID RESERVOIR - Stores brake fluid and supplies to tandem master cylinder. Brake fluid reservoir has 2 separate compartments for front circuit and rear circuit.

MILE



drum_break.exe

SAMPLE LEAFLET



Disk_break.exe

MARSHAL 2000

BRAKES

**: SERVICE - HYDRAULIC WITH TANDEM
MASTER CYLINDER. VACUUM ASSISTED
SERVO BRAKES**

MILE

ANATOMY OF AN AUTOMOBILE

(REAR WHEEL DRIVE - 2WD)

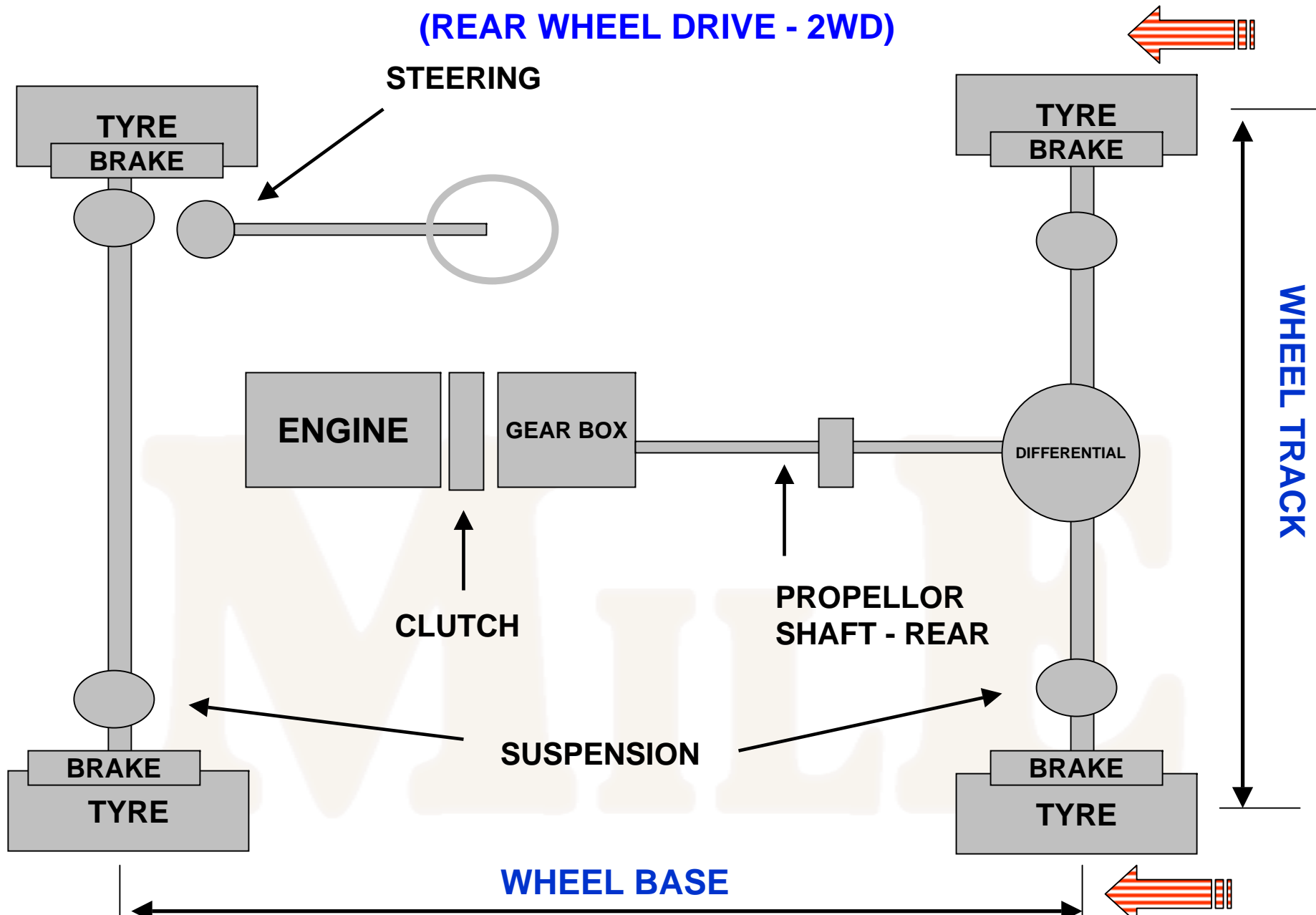

SYSTEMS IN AN AUTOMOBILE

A. POWER TRAIN SYSTEM

- **POWER PLANT (POWER GENERATION - ENGINE)**

- **ENGINE**
- **FUEL SYSTEM**
- **INTAKE SYSTEM**
- **EXHAUST SYSTEM**
- **COOLING SYSTEM**

- **DRIVE LINE (POWER TRANSMISSION)**

- **CLUTCH**
- **GEAR BOX/TRANSMISSION**
- **TRANSFER CASE**
- **DIFFERENTIAL**
- **WHEELS/TYRES**

B. RUNNING SYSTEM

- **SUSPENSION**
- **STEERING**
- **BRAKING**

C. COMFORT SYSTEM

- **HVAC/AC/HEATER SYSTEM**
- **SEATING/UPHOLSTRY/FACIA/INSTRUMENTS**
- **AUDIO/VIDEO/GPS**



COMFORT/CONVENIENCE SYSTEMS

- **POWER PLANT GENERATES** THE POWER/TORQUE
- **DRIVELINE MODIFIES & TRANSMITS** THE TORQUE
- **THE RUNNING SYSTEM CONTROLS** THE VEHICLE

COMFORT/CONVENIENCE SYSTEM CONSISTS OF

- HVAC/AC** - Provides a comfortable climate inside the vehicle
- ELECTRICALS** - Operates a host of electrical aggregates
- INSTRUMENTS** - Provides information about vehicle systems
- AUDIO/VIDEO** - Provides in-car entertainment
- SEAT/UPHOLSTRY**

SYSTEMS IN AN AUTOMOBILE

A. POWER TRAIN SYSTEM

- **POWER PLANT (POWER GENERATION - ENGINE)**

- **ENGINE**
- **FUEL SYSTEM**
- **INTAKE SYSTEM**
- **EXHAUST SYSTEM**
- **COOLING SYSTEM**

- **DRIVE LINE (POWER TRANSMISSION)**

- **CLUTCH**
- **GEAR BOX/TRANSMISSION**
- **TRANSFER CASE**
- **DIFFERENTIAL**
- **WHEELS/TYRES**

B. RUNNING SYSTEM

- **SUSPENSION**
- **STEERING**
- **BRAKING**

C. COMFORT SYSTEM

- **HVAC/AC/HEATER SYSTEM** ←
- **SEATING/UPHOLSTRY/FACIA/INSTRUMENTS**
- **AUDIO/VIDEO/GPS**

HEATING, VENTILATION & COOLING

HVAC SYSTEM ALLOWS THE PASSENGERS TO **CONTROL THE CLIMATIC CONDITIONS** INSIDE THE VEHICLE TO THEIR COMFORT & CONVIENIENCE.

THE VARIOUS FUNCTIONS OF THE HVAC SYSTEM ARE :

COOLING - Brings down the temperature of air inside the vehicle when the outside temperatures are very high

HEATING - Brings up the temperature of inside the vehicle when the outside temperatures are very low.

VENTILATION - Allows to purge the stale air inside the vehicle and bring in fresh air from outside.

HEATING, VENTILATION & COOLING

(HVAC SYSTEM - SCORPIO)

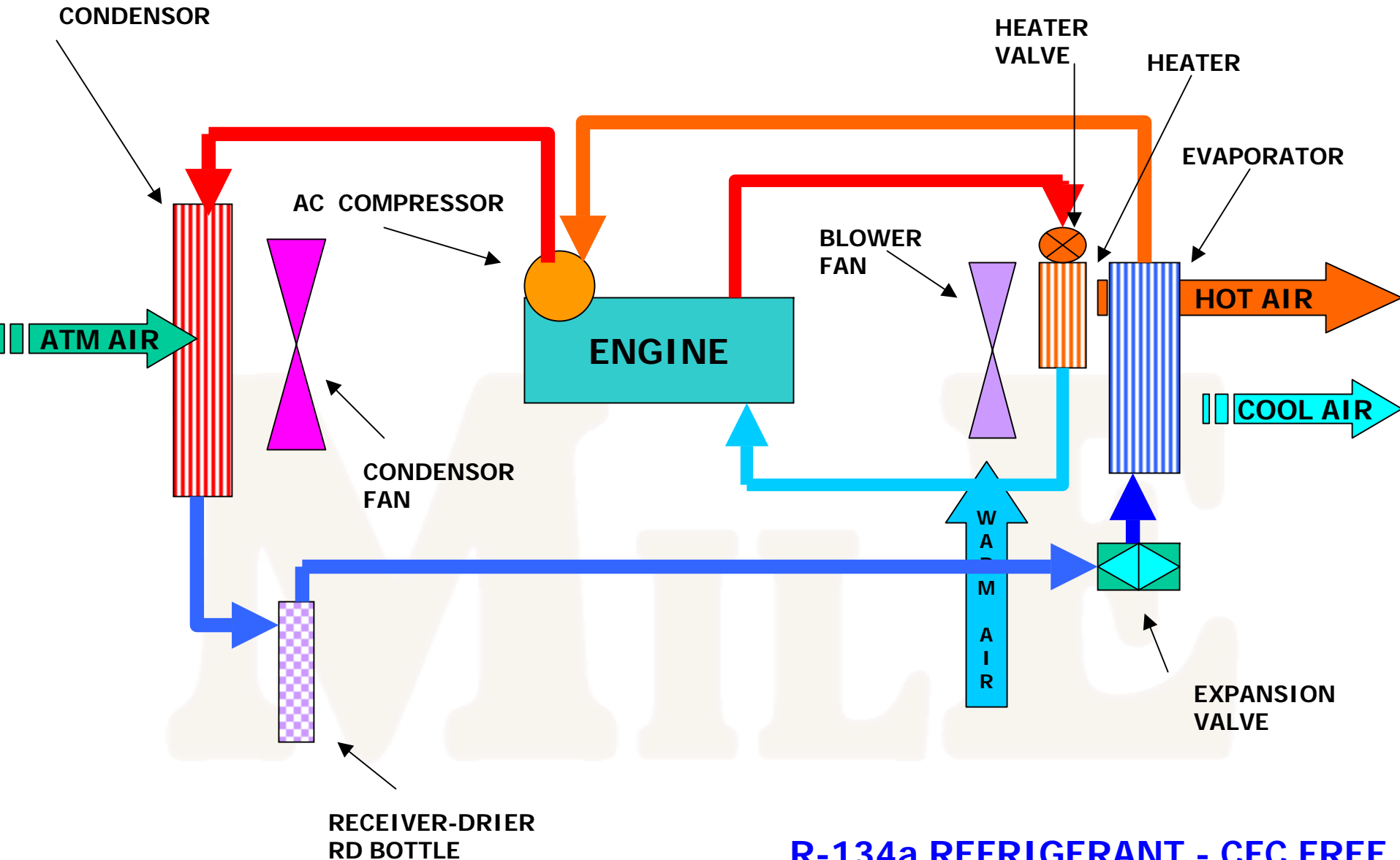

R-134a REFRIGERANT - CFC FREE

HEATING, VENTILATION & COOLING

(HVAC SYSTEM - SCORPIO)

THE HVAC SYSTEM FITTED ON SCORPIO IS OF **AIR MIXING TYPE**, WHERE THE DESIRED TEMPERATURE IS OBTAINED BY MIXING THE HOT AIR FROM HEATER & COLD AIR FROM THE EVAPORATOR.

AIR MIXING IS CONTROLLED BY ADJUSTING THE VARIOUS FLAPS & THE HEATER VALVE INSIDE THE HVAC UNIT.

SCORPIO USES **R134a REFRIGERANT**, WHICH IS CFC-FREE

MILLE

HEATING, VENTILATION & COOLING

(AC SYSTEM - BOLERO)

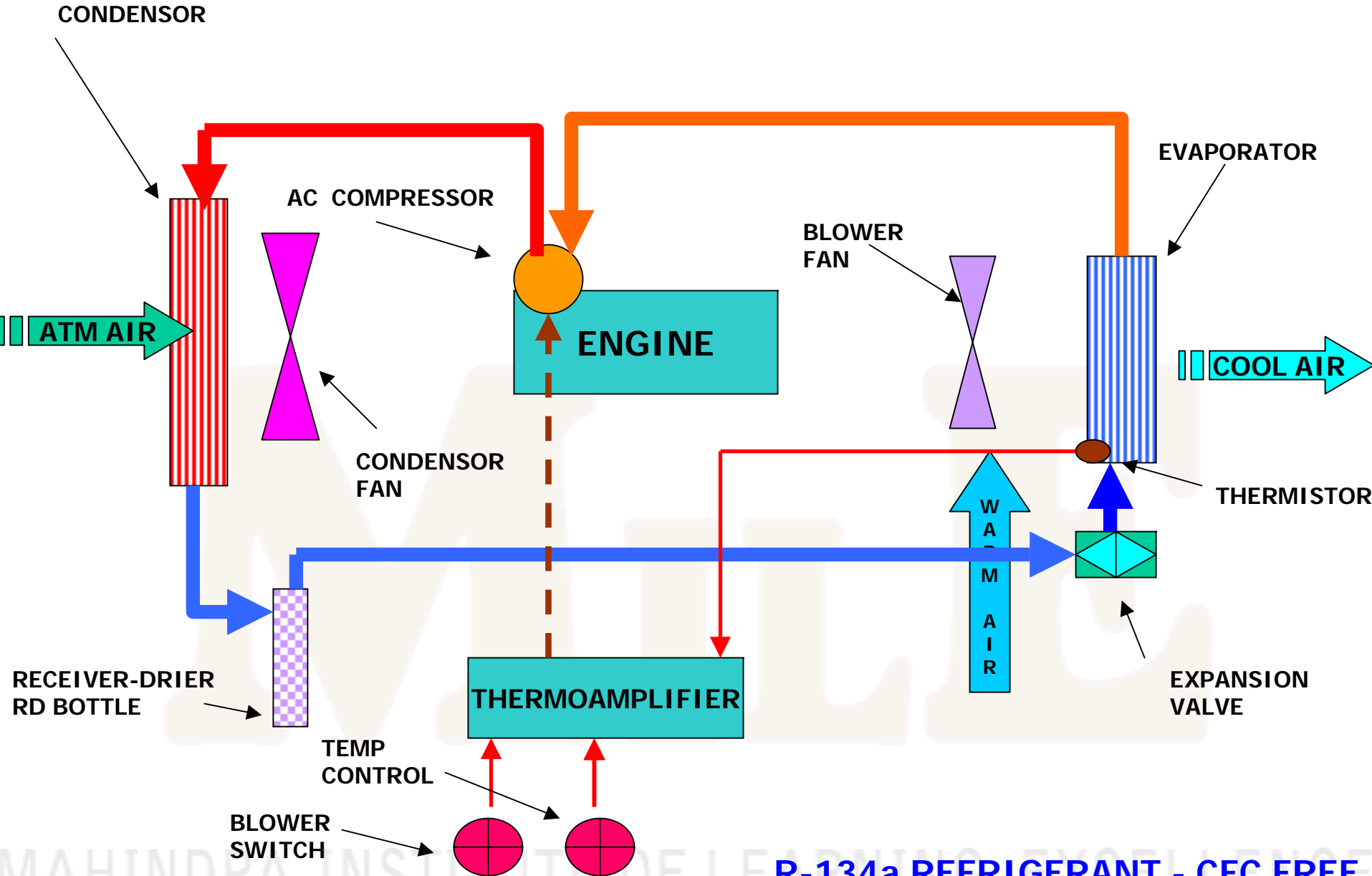

HEATING, VENTILATION & COOLING

(AC SYSTEM - BOLERO)

THE AC SYSTEM FITTED ON BOLERO IS OF **THERMO AMPLIFIER TYPE**, WHERE THE DESIRED TEMPERATURE IS OBTAINED BY SWITCHING ON & OFF THE AC COMPRESSOR.

REQUIRED TEMPERATURE IS SET BY ADJUSTING THE TEMPERATURE CONTROL KNOB & BLOWER SWITCH.

BOLERO USES **R134a REFRIGERANT**, WHICH IS CFC-FREE

MILLE

HEATING, VENTILATION & COOLING

(AC + HEATER SYSTEM - BOLERO)

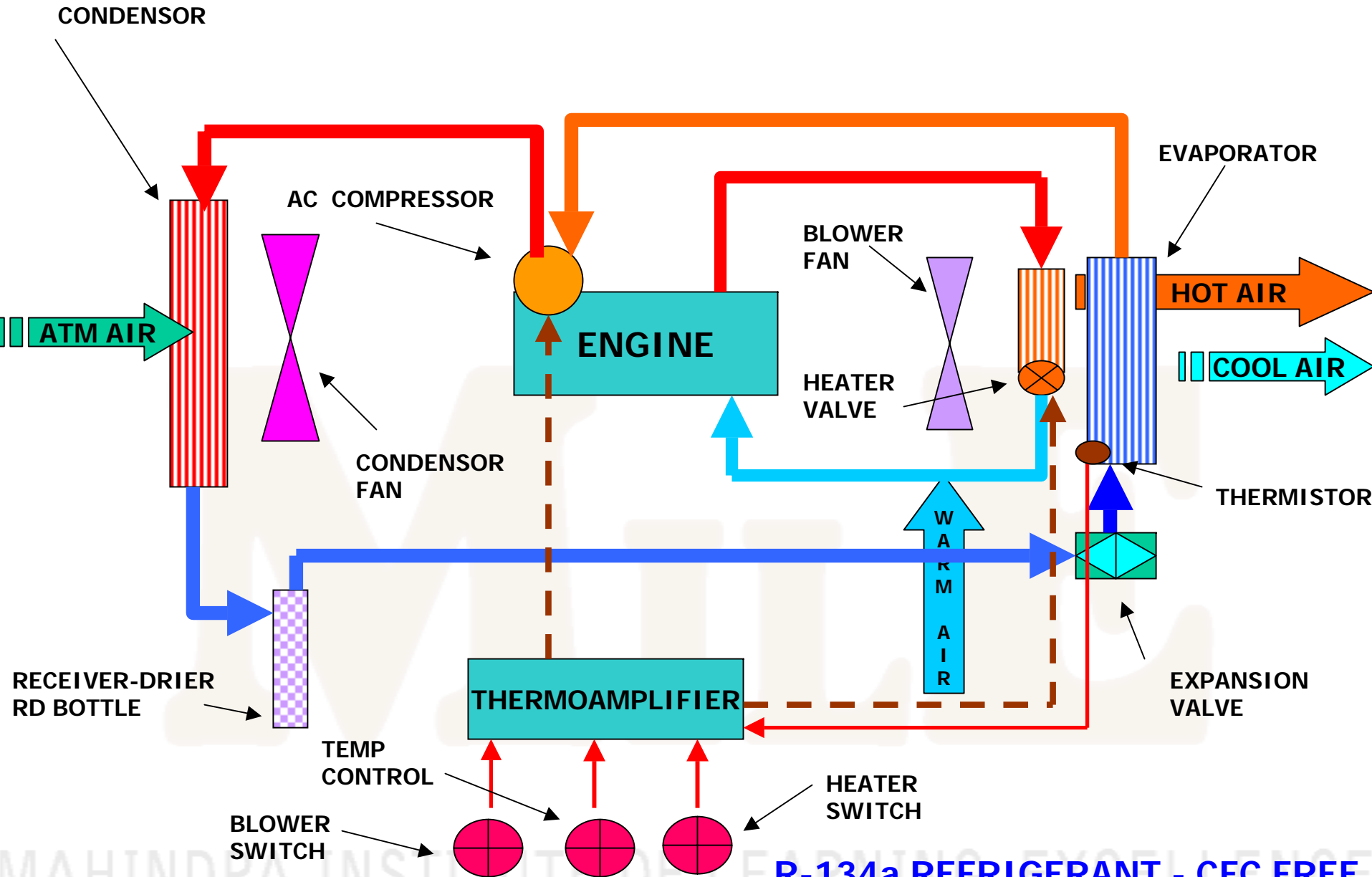

R-134a REFRIGERANT - CFC FREE

HEATING, VENTILATION & COOLING

(AC + HEATER SYSTEM - BOLERO)

THE AC + HEATER SYSTEM FITTED ON BOLERO IS OF **THERMO AMPLIFIER + HOT WATER VALVE TYPE**, WHERE THE DESIRED TEMPERATURE IS OBTAINED BY SWITCHING ON & OFF THE AC COMPRESSOR FOR COOLING AND SWITCHING ON THE HEATER FOR HEATING

AC AND HEATER CANNOT BE OPERATED SIMULTANEOUSLY

REQUIRED TEMPERATURE IN **AC MODE** IS SET BY ADJUSTING THE TEMPERATURE CONTROL KNOB & BLOWER SWITCH.

REQUIRED TEMPERATURE CANNOT BE ADJUSTED IN **HEATER MODE**. HEATER HAS TO BE SWITCHED OFF FOR TEMPERATURE CONTROL

BOLERO USES **R134a REFRIGERANT**, WHICH IS CFC-FREE

HEATING, VENTILATION & COOLING

- 1. COMPRESSOR** - Compressor sucks the refrigerant from evaporator , compresses the same and delivers to condenser.
- 2. CONDENSOR** - Condenser is similar to radiator , where the hot, compressed refrigerant is cooled.
- 3. CONDENSOR FAN** - Condenser fan sucks fresh atmospheric air through the condenser aiding in cooling of the refrigerant inside the condenser.
- 4. RECEIVER-DRIER (RD BOTTLE)** - Receives the compressed and cooled refrigerant and removes any humidity from the refrigerant.
- 5. EXPANSION VALVE** - Receives cooled & compressed refrigerant and expands the refrigerant and passes it in to the evaporator. Expanded refrigerent gases are very cold
- 6. EVAPORATOR** - Evaporator is similar to radiator. The expanded cold refrigerant is passed over warm air from inside the vehicle.

HEATING, VENTILATION & COOLING

7. BLOWER - Blower fan sucks warm air from inside the vehicle and passes it over the evaporator which has cold refrigerant on the inner side , thus cooling the vehicle interiors.

8. HEATER - Heater is similar to radiator , where hot coolant from the engine is circulated on the inside. Blower fan passes cold air from the vehicle interior.

MILE

ELECTRICAL SYSTEM

THE VEHICLE ELECTRICAL SYSTEM CAN BE BROADLY CLASSIFIED AS :

POWER GENERATION - Generation of electrical power when the engine is running - **Alternator**

STORAGE - Storage of electrical energy for use in the vehicle when the engine is not running - **Battery**

TRANSMISSION & CONTROLS - Transmits & controls the power flow to the consumers - **Wiring harness, Fuses, Relays.**

CONSUMERS - Electrical aggregates which consume electricity for functioning.

VEHICLE ELECTRICAL SYSTEM OPERATE ON 12 V DC

ELECTRICAL SYSTEM

POWER GENERATION - Power generation is done by the **Alternator**. Alternator is driven by the engine through a belt. Alternator consists of :

Generation Unit - Generates AC power

Rectifier - Rectifies the AC and converts to DC

Regulator - Regulates the alternator output voltage to a maximum of 14.5 Volts

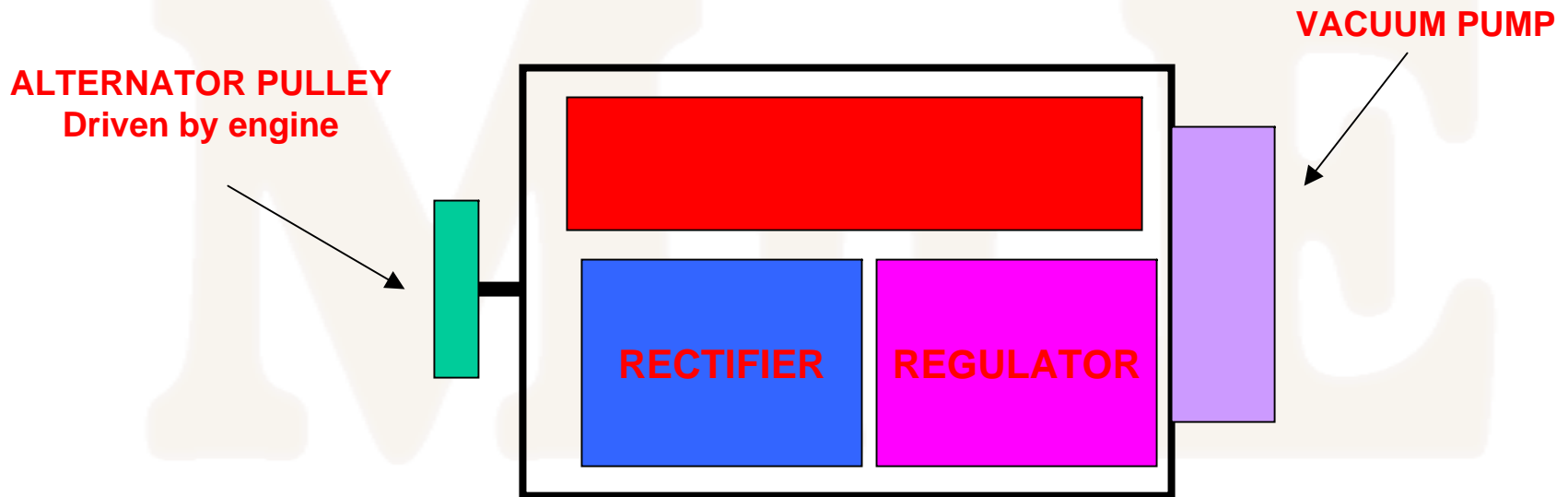

ELECTRICAL SYSTEM

STORAGE - The electrical energy generated by the Alternator is stored in a **Battery** for use when the engine is not running. Battery stores the energy in an electro-chemical form.

While starting the vehicle , the starter motor , takes electrical energy from the battery. This drains the battery. As soon as the engine is started, the alternator starts charging the battery .



ELECTRICAL SYSTEM

TRANSMISSION AND CONTROLS - The electrical energy from alternator or battery is transmitted to the various consumers through wires. A bunch of wires is called **wiring harness**. Also, the flow of electrical energy is controlled by various controls, namely, **Fuses, Relays, Switches etc.**

MILE

ELECTRICAL SYSTEM

CONSUMERS - Consumers are electrical aggregates which consume electricity for functioning. Some of the major consumers are :

- LIGHTING SYSTEM
- WINDSHIELD WIPE/WASH SYSTEM
- HEATERS/DEMISTERS
- WINDOW OPERATING SYSTEMS
- DOOR LOCKING SYSTEM
- ENGINE MANAGEMENT SYSTEMS
- STARTING SYSTEM
- HVAC - BLOWER FAN/CONDENSOR FAN

WILE

VEHICLE DIMENSIONS

OVERALL WIDTH

OVERALL HEIGHT

OVERALL LENGTH

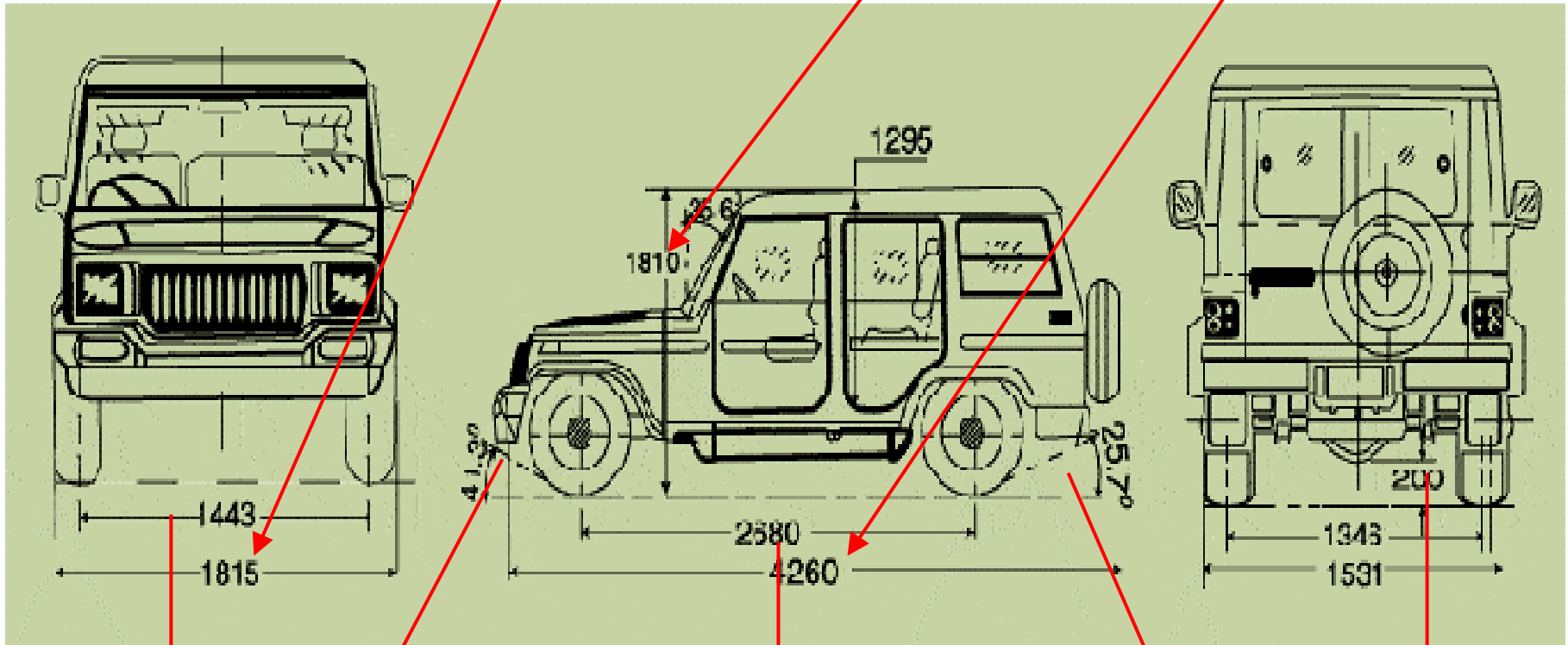

ANGLE OF APPROACH

ANGLE OF DEPARTURE

WHEEL BASE

WHEEL TRACK

GROUND CLEARANCE

VEHICLE WEIGHTS

KERB WEIGHT - The unladen weight of the vehicle - No passengers

GVW (Gross Vehicle Weight) - The fully laden weight of the vehicle with passengers/goods.

PAYLOAD - The difference between GVW and Kerb weight

MILE

VEHICLE PARAMETERS

GRADEABILITY - The maximum gradient a vehicle can climb, under GVW conditions, in first gear.

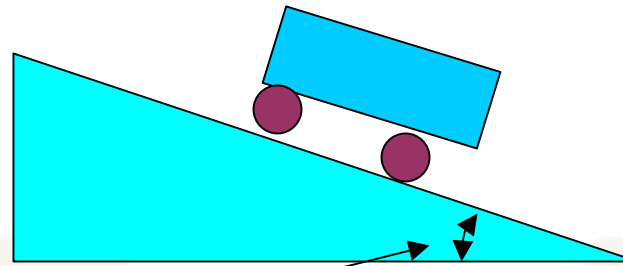

GRADEABILITY , Deg

MILLE

VEHICLE PARAMETERS

MINIMUM TURNING RADIUS - The radius of the circle made by the outermost point in the vehicle, while taking a turn with maximum wheel turning

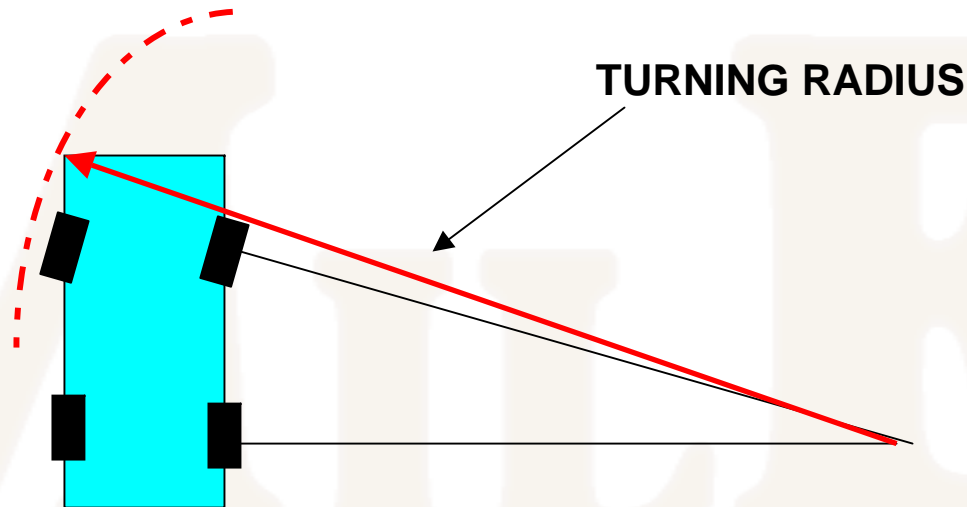

VEHICLE IDENTIFICATION NUMBER

1	2	3	4	5	6	7	8	9	10	11	12	13	14	15	16	17
WMI			VDS						VIS							
A	AN	A	A	A	N	A	A	A	A/N	N	A	N	N	N	N	N
			MODEL CODE		DRIVE	ENGINE		TRANSMISSION	YEAR	PLANT	MONTH	VEHICLE SERIAL NO.				

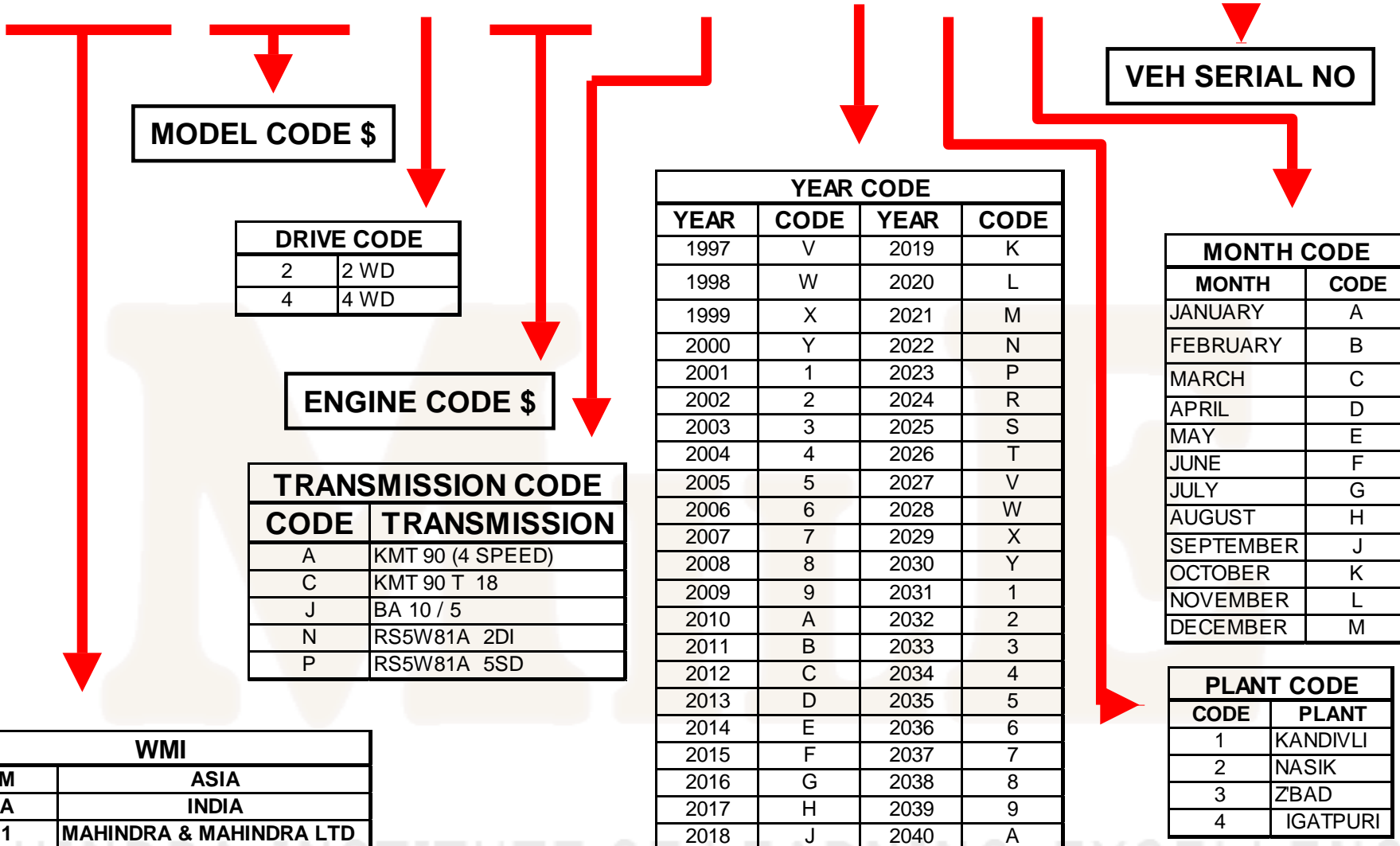

MODEL CODE \$

DRIVE CODE	
2	2 WD
4	4 WD

ENGINE CODE \$

TRANSMISSION CODE	
CODE	TRANSMISSION
A	KMT 90 (4 SPEED)
C	KMT 90 T 18
J	BA 10 / 5
N	RS5W81A 2DI
P	RS5W81A 5SD

YEAR CODE			
YEAR	CODE	YEAR	CODE
1997	V	2019	K
1998	W	2020	L
1999	X	2021	M
2000	Y	2022	N
2001	1	2023	P
2002	2	2024	R
2003	3	2025	S
2004	4	2026	T
2005	5	2027	V
2006	6	2028	W
2007	7	2029	X
2008	8	2030	Y
2009	9	2031	1
2010	A	2032	2
2011	B	2033	3
2012	C	2034	4
2013	D	2035	5
2014	E	2036	6
2015	F	2037	7
2016	G	2038	8
2017	H	2039	9
2018	J	2040	A

VEH SERIAL NO

MONTH CODE	
MONTH	CODE
JANUARY	A
FEBRUARY	B
MARCH	C
APRIL	D
MAY	E
JUNE	F
JULY	G
AUGUST	H
SEPTEMBER	J
OCTOBER	K
NOVEMBER	L
DECEMBER	M

WMI	
M	ASIA
A	INDIA
1	MAHINDRA & MAHINDRA LTD

PLANT CODE	
CODE	PLANT
1	KANDIVLI
2	NASIK
3	ZBAD
4	IGATPURI

\$ - REF CHART