

Partial Differential Equation

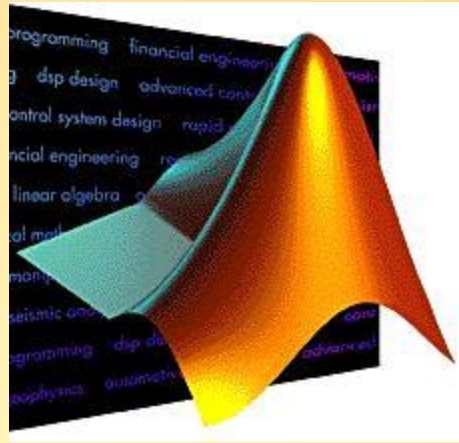

Persamaan differensial parsial secara umum untuk orde dua

Persamaan differensial parsial secara umum untuk orde dua dalam variabel bebas x dan y dapat dinyatakan sebagai berikut :

$$A \frac{\partial^2 u}{\partial x^2} + B \frac{\partial^2 u}{\partial x \partial y} + C \frac{\partial^2 u}{\partial y^2} + D \left(x, y, u, \frac{\partial u}{\partial x}, \frac{\partial u}{\partial y} \right) = 0$$

$$A \frac{\partial^2 u}{\partial x^2} + B \frac{\partial^2 u}{\partial x \partial y} + C \frac{\partial^2 u}{\partial y^2} + D \left(x, y, u, \frac{\partial u}{\partial x}, \frac{\partial u}{\partial y} \right) = 0$$

Persamaan differensial parsial dapat diklasifikasikan tergantung dari nilai $B^2 - 4AC$.

- jika $B^2 - 4AC < 0$, maka persamaan Eliptik
- jika $B^2 - 4AC = 0$, maka persamaan Parabolik
- jika $B^2 - 4AC > 0$, maka persamaan Hiperbolik

- Jika koefisien A , B , dan C dalah fungsi x , y , dan/atau u , persamaan mungkin berubah dari satu klasifikasi menjadi klasifikasi lain pada titik bervariasi.
- Dalam teknik kimia persamaan yang sering dijumpai adalah persamaan differensial eliptik dan parabolik, sehingga kedua persamaan itulah yang akan dibahas dalam kuliah ini.

PERSAMAAN DIFFERENSIAL ELIPTIK

$$A \frac{\partial^2 u}{\partial x^2} + B \frac{\partial^2 u}{\partial x \partial y} + C \frac{\partial^2 u}{\partial y^2} + D \left(x, y, u, \frac{\partial u}{\partial x}, \frac{\partial u}{\partial y} \right) = 0$$

Persamaan differensial eliptik terbentuk jika koefisien A dan C pada persamaan umum sama dengan 1 dan B sama dengan nol, sehingga $B^2 - 4AC < 1$.

Ada 2 type persamaan differensial eliptik yang akan dibahas, yaitu

- Persamaan Laplace

$$A \frac{\partial^2 u}{\partial x^2} + C \frac{\partial^2 u}{\partial y^2} = 0$$

- Persamaan Poisson

$$A \frac{\partial^2 u}{\partial x^2} + C \frac{\partial^2 u}{\partial y^2} + D \left(x, y, u, \frac{\partial u}{\partial x}, \frac{\partial u}{\partial y} \right) = 0$$

PERSAMAAN LAPLACE

- Persamaan Laplace sering muncul dari penyusunan persoalan perpindahan panas dalam suatu plat.
- Bentuk paling sederhana persamaan Laplace adalah

$$\frac{\partial^2 u}{\partial x^2} + \frac{\partial^2 u}{\partial y^2} = 0$$

Penyelesaian persamaan Laplace adalah metode beda hingg.

$$\frac{\partial^2 u}{\partial x^2} + \frac{\partial^2 u}{\partial y^2} = \frac{u_{i+1,j} - 2u_{i,j} + u_{i-1,j}}{(\Delta x)^2} + \frac{u_{i,j+1} - 2u_{i,j} + u_{i,j-1}}{(\Delta y)^2}$$

Jika diambil $\Delta x = \Delta y = h$

$$\frac{\partial^2 u}{\partial x^2} + \frac{\partial^2 u}{\partial y^2} = \frac{1}{h^2} [u_{i+1,j} + u_{i-1,j} + u_{i,j+1} + u_{i,j-1} - 4u_{i,j}] = 0$$

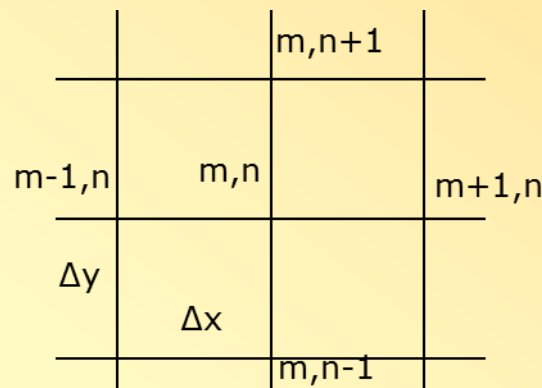

Contoh 1

Plat tembaga tipis dengan ukuran 3 cm x 3 cm. Permukaan salah satu sisi dipertahankan 500 °C dan ketiga sisi yang lain dipertahankan pada suhu 100 °C. Permukaan plat diisolasi sehingga panas mengalir arah x dan y saja. Tentukan distribusi suhu plat tersebut pada keadaan tunak (*steady*).

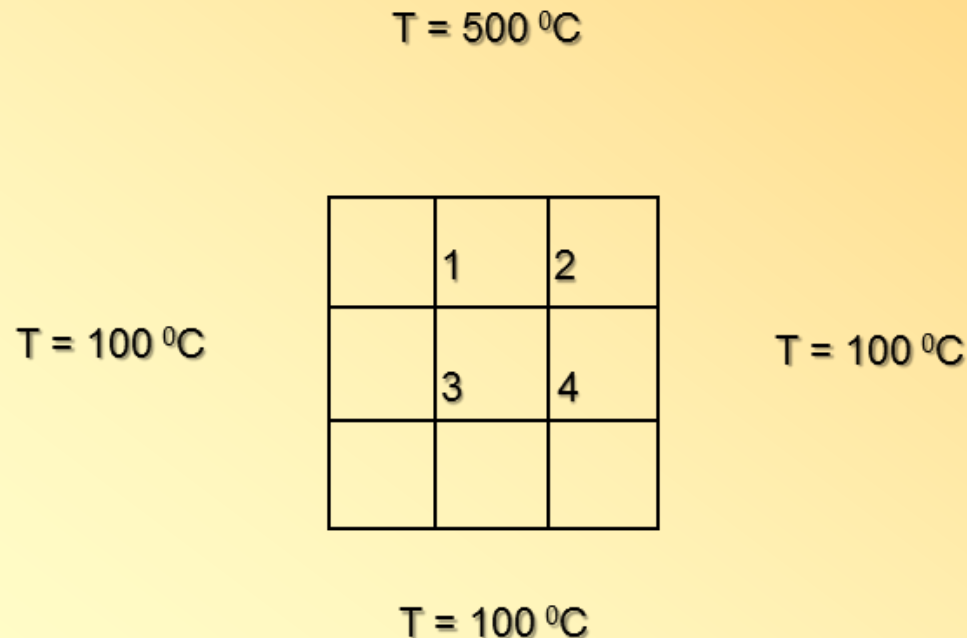

09 Parsial Differential Equation

$$\frac{\partial^2 u}{\partial x^2} + \frac{\partial^2 u}{\partial y^2} = \frac{1}{h^2} [u_{i+1,j} + u_{i-1,j} + u_{i,j+1} + u_{i,j-1} - 4u_{i,j}] = 0$$

Contoh 2

Plat tembaga tipis dengan ukuran 6 cm x 8 cm. Permukaan salah satu sisi dengan panjang 6 cm dipertahankan 100 °C dan ketiga sisi yang lain dipertahankan pada suhu 40 °C. Permukaan plat diisolasi sehingga panas mengalir arah x dan y saja. Tentukan distribusi suhu plat tersebut pada keadaan tunak (steady).

next

Contoh 3

Tentukan distribusi temperatur pada sebuah plat bujursangkar yang salah satu sisinya mengikuti persamaan $T = 100 \cdot \sin(\pi \cdot y)$, sedang ketiga sisi yang lain sama dengan nol.

```

clear;
N=30;

for j=0:N-2
    for i=1:N-2
        X(i+j*(N-1))=0;
    end
end
for i=1:N-1
    X(i*(N-1))=-100*sin(i*pi/N);
end

```

```

% Penyusunan matriks A
for i=1:(N-1)*(N-1)
    A(i,i)=-4;
end
for i=1:N-2
    for k=0:N-2
        A(i+k*(N-1),i+1+k*(N-1))=1;
    end
end
for k=0:N-3
    for i=1:N-1
        A(i+k*(N-1),i+(k+1)*(N-1))=1;
    end
end
for i=1:(N-1)*(N-1)
    for j=1:i
        A(i,j)=A(j,i);
    end
end

```

```
% Inversi Matriks dan Perhitungan temperatur
```

```
M=inv(A);
```

```
U=M*X';
```

```
% Plot hasil pada bentuk contour
```

```
for i=1:N-1
```

```
    for j=1:N-1
```

```
        x(i,j)=U(j+(i-1)*(N-1));
```

```
    end
```

```
end
```

```
[i,j]=meshgrid(1:1:N-1,1:1:N-1);
```

```
[c,h]=contourf(i,j,x);
```

09 Parsial Differential Equation

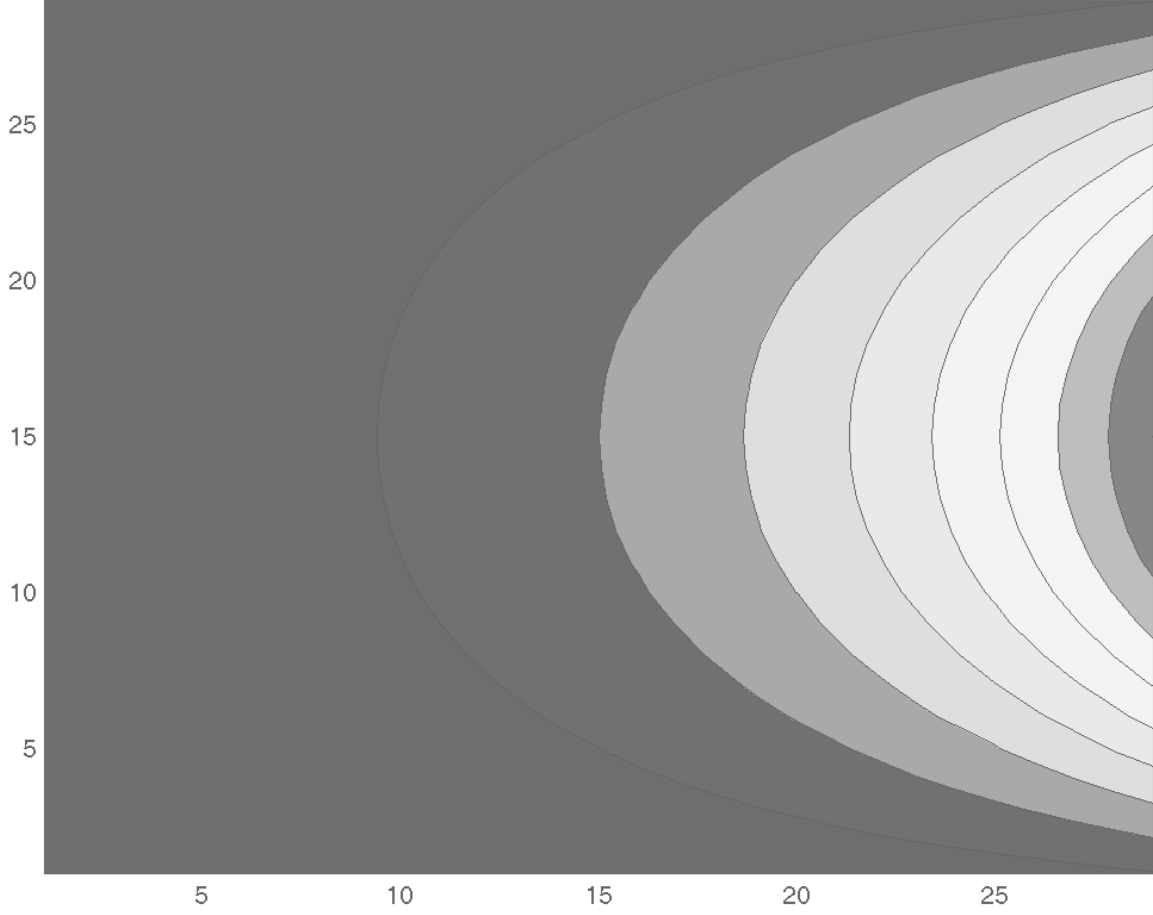

Contoh 4

Plat tipis dari baja mempunyai ukuran 10 cm x 20 cm. Jika salah satu sisi ukuran 10 cm dijaga pada 100 °C dan ketiga sisi yang lain dijaga pada 0 °C. Tentukan profil temperatur pada plat. Untuk baja $k = 0,16$ kal/detik.cm².C/cm.

$$\frac{\partial^2 u}{\partial x^2} + \frac{\partial^2 u}{\partial y^2} = 0$$

dengan $u(x,0) = 0,$

$$u(x,10) = 0,$$

$$u(0,y) = 0,$$

$$u(20,y) = 100.$$

```

clear;
N=20;
M=10;

for j=0:N-2
    for i=1:M-2
        X(i+j*(M-1))=0;
    end
end
for i=1:M-1
    X(i*(N-1))=-100;
end

```

```

% Penyusunan matriks A
for i=1:(N-1)*(M-1)
    A(i,i)=-4;
end
for i=1:N-2
    for k=0:M-2
        A(i+k*(N-1),i+1+k*(N-1))=1;
    end
end
for k=0:M-3
    for i=1:N-1
        A(i+k*(N-1),i+(k+1)*(N-1))=1;
    end
end
for i=1:(N-1)*(M-1)
    for j=1:i
        A(i,j)=A(j,i);
    end
end

```

```
% Inversi Matriks dan Perhitungan Temperatur
```

```
G=inv(A);
```

```
U=G*X';
```

```
% Plot hasil bentuk contour
```

```
for i=1:M-1
```

```
    for j=1:N-1
```

```
        x(i,j)=U(j+(i-1)*(N-1));
```

```
    end
```

```
end
```

```
T = x
```

```
[i,j]=meshgrid(1:1:N-1,1:1:M-1);
```

```
[c,h]=contourf(i,j,x);
```

Fungsi ellipgen

```

function [a,om]=ellipgen(nx,hx,ny,hy,G,F,bx0,bxn,by0,byn)
%   Penyelesaian persamaan PD Parsial Eliptik
%   
$$\frac{d^2 Z}{d x^2} + \frac{d^2 Z}{d y^2} + G(x,y)*Z = F(x,y)$$

%   pada plat rektanguler
%   Cara menggunakan fungsi ini
%   hx,hy = ukuran titik arah x, y
%   F, G = array (ny+1,nx+1) representasi F(x,y), G(x,y)
%   bx0, bxn = vektor baris kondisi batas pada x0, xn
%   by0, byn = vektor baris kondisi batas pada y0, yn
%   a = array (ny+1,nx+1) penyelesaian
%
%   Nama File : ellipgen.m
%   Surakarta, Oktober 2005
%   -----

nmax=(nx-1)*(ny-1); r=hy/hx;
a=zeros(ny+1,nx+1); p=zeros(ny+1,nx+1);
if nargin==6

```

09 Parsial Differential Equation

```
nmax=(nx-1)*(ny-1); r=hy/hx;
a=zeros(ny+1,nx+1); p=zeros(ny+1,nx+1);
if nargin==6
    ncase=0;mode=F;
end
if nargin==10
    test=0;
    if F==zeros(ny+1,nx+1), test=1; end
    if bx0==zeros(1,ny+1), test=test+1; end
    if bxn==zeros(1,ny+1), test=test+1; end
    if by0==zeros(1,nx+1), test=test+1; end
    if byn==zeros(1,nx+1), test=test+1; end
    if test==5
        disp(' WARNING ')
        disp(' ')
        break
    end
    bx0=bx0(1,ny+1:-1:1); bxn=bxn(1,ny+1:-1:1);
    a(1,:)=byn; a(ny+1,:)=by0;
    a(:,1)=bx0; a(:,nx+1)=bxn;ncase=1;
end
for i=2:ny
    for j=2:nx
        nn=(i-2)*(nx-1)+(j-1);
        q(nn,1)=1; q(nn,2)=j; p(1,j)=nn;
    end
end
C=zeros(nmax,nmax); e=zeros(nmax,1); on=zeros(nmax,1);
if ncase==1, g=zeros(nmax,1); end
for i=2:ny
    for j=2:nx
        nn=p(1,j); C(nn,nn)=-(2+2*r^2); e(nn)=hy^2*G(1,j);
        if ncase==1, g(nn)=g(nn)+hy^2*F(1,j); end
        if p(1+1,j)==0
            np=p(1+1,j); C(nn,np)=1;
        else
            if ncase==1, g(nn)=g(nn)-by0(j); end
        end
        if p(1-1,j)==0
            np=p(1-1,j); C(nn,np)=1;
        end
    end
end
```

Distribusi Temperatur pada Plat Rektanguler

Tentukan distribusi temperatur dalam suatu plat rektanguler, dengan kondisi batas sebagai berikut

$$x = 0, T = 100y$$

$$x = 3, T = 250y$$

$$y = 0, T = 0$$

$$y = 2, T = 200 + (100/3)x^2$$

Penyelesaian untuk ukuran 6 x 6.

Program Matlab

```
clear all
```

```
% Jumlah titik arah x, y
```

```
nx=6; ny=6;
```

```
% Ukuran titik arah x, y
```

```
hx=0.5; hy=0.3333;
```

```
% Input data pada kondisi batas
```

```
by0=[0 0 0 0 0 0];
```

```
byn=[200 208.33 233.33 275 333.33 408.33 500];
```

```
bx0=[0 33.33 66.67 100 133.33 166.67 200];
```

```
bxn=[0 83.33 166.67 250 333.33 416.67 500];
```

```
% Penyelesaian dg fungsi ellipgen
```

```
F=zeros(ny+1,nx+1); G=F; % PD Laplace
```

```
a=ellipgen(nx, hx, ny, hy, G, F, bx0, bxn, by0, byn);
```

```
% Plot hasil
```

```
contourf(a)
```

```
xlabel('Titik-titik dalam arah x');
```

```
ylabel('Titik-titik dalam arah y');
```

09 Parsial Differential Equation

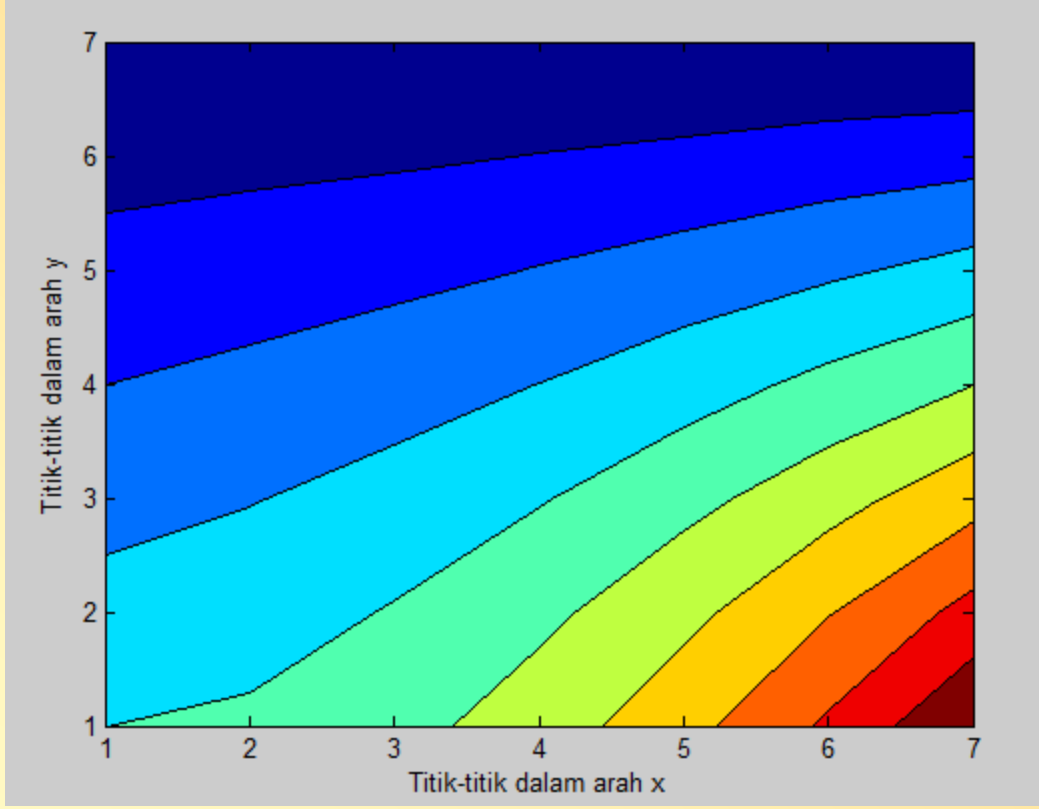

PERSAMAAN POISSON

$$A \frac{\partial^2 u}{\partial x^2} + C \frac{\partial^2 u}{\partial y^2} = F \left(x, y, u, \frac{\partial u}{\partial x}, \frac{\partial u}{\partial y} \right)$$

Tentukan defleksi membran bujursangkar seragam dengan ujung-ujung tetap dijaga. Sedang beban distribusi dapat didekati dengan suatu beban pada suatu titik. Permasalahan ini mengikuti persamaan Poisson dengan $F(x,y)$ menunjukkan beban membran.

```
% Jumlah titik arah x, y
nx=6; ny=6;
% Ukuran titik arah x, y
hx=1/6; hy=1/6;
% Input data pada kondisi batas
by0=[0 0 0 0 0 0 0];
byn=[0 0 0 0 0 0 0];
bx0=[0 0 0 0 0 0 0];
bxn=[0 0 0 0 0 0 0];
% Penyelesaian dg fungsi ellipgen
F=-ones(ny+1,nx+1); G=zeros(nx+1,ny+1);
a=ellipgen(nx, hx, ny, hy, G, F, bx0, bxn, by0, byn);
% Plot hasil
surfl(a)
axis([1 7 1 7 0 0.1])
xlabel('titik-titik arah x');
ylabel('titik-titik arah y ');
zlabel('tebal');
```

09 Parsial Differential Equation

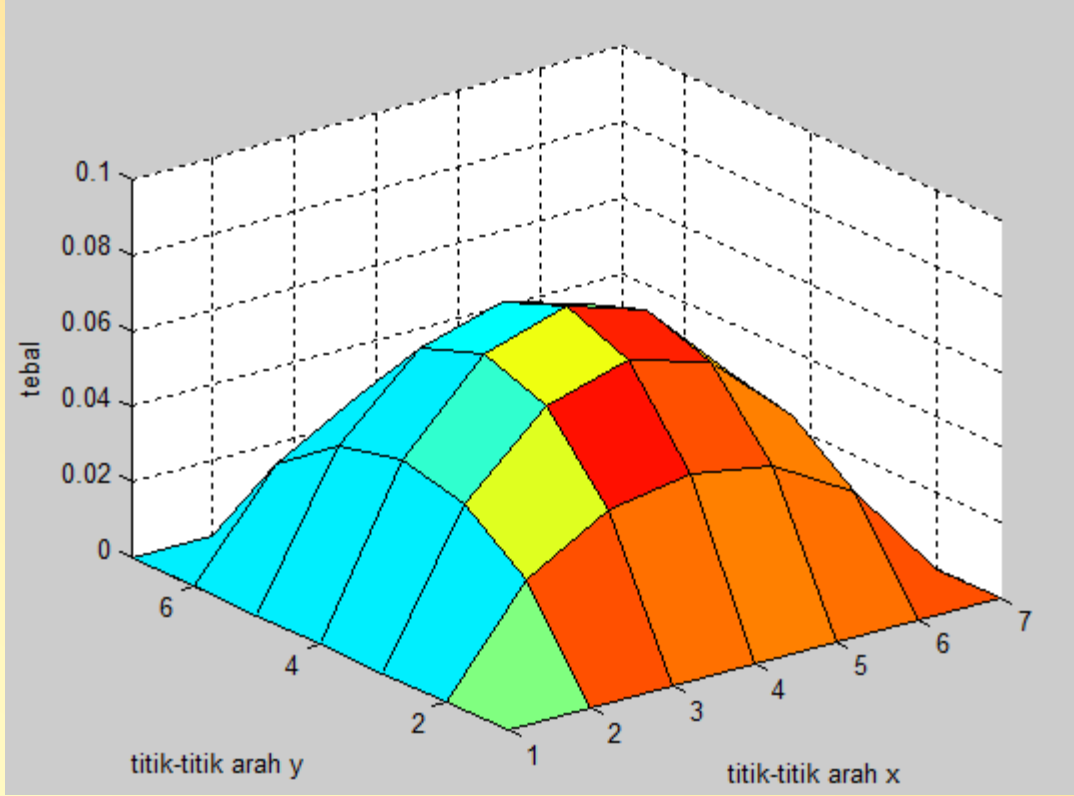

PERSAMAAN PARABOLIK

$$\frac{\partial^2 u}{\partial x^2} = \frac{cp}{k} \frac{\partial u}{\partial t}$$

METODE EKSPLISIT

$$\frac{\partial^2 u}{\partial x^2} = \frac{u_{i+1}^j - 2u_i^j + u_{i-1}^j}{(\Delta x)^2}$$

$$\frac{\partial u}{\partial t} = \frac{u_i^{j+1} - u_i^j}{\Delta t}$$

$$u_i^{j+1} = \frac{k\Delta t}{c\rho(\Delta x)^2} (u_{i+1}^j + u_{i-1}^j) + \left(1 - \frac{2k\Delta t}{c\rho(\Delta x)^2}\right) u_i^j$$

Penyederhanaan $\frac{k\Delta t}{c\rho(\Delta x)^2} = \frac{1}{2} = \frac{1}{M}$

$$u_i^{j+1} = \frac{1}{2} (u_{i+1}^j + u_{i-1}^j)$$

Distribusi Temperatur sebagai Fungsi Waktu pada Plat Tipis

Plat besi yang sangat luas mempunyai tebal 2 cm. Temperatur mula-mula dalam plat merupakan fungsi jarak dari salah satu sisinya sebagai berikut :

$$u = 100x \quad \text{untuk } 0 < x < 1,$$

$$u = 100(2 - x) \quad \text{untuk } 1 < x < 2.$$

Tentukan temperatur tebal plat sebagai fungsi x dan t , jika kedua permukaan tetap dijaga 0°C . Untuk besi $k = 0,13$ kal/detik.cm.
 $^\circ\text{C}$, $c = 0,11$ cal/g. $^\circ\text{C}$, $\rho = 7,8$ g/cm³.

$$\frac{k\Delta t}{c\rho(\Delta x)^2} = \frac{1}{2} = \frac{1}{M}$$

$\Delta x = 0,25$ sehingga $\Delta t = 0,206$ detik

```
clc
clear all

% Data-data
L=2;
k=0.13;
c=0.11;
rho=7.8;

% Interval
N=8;
M=0.5;
delx=L/N;
delt=M*c*rho*delx^2/k;
xo=0;
Jend=20;
```

```
for i=1:N+1
    x(i)=xo+delx*(i-1);
end

% Kondisi awal
for i=1:ceil((N+1)/2)
    u(1,i)=100*x(i);
end

for i=N+1:-1:ceil((N+1)/2)
    u(1,i)=100*(2-x(i));
end

for i=1:Jend
    t(i)=delt*i;
end
```

```
for j=1:Jend
    for i=2:ceil((N+1)/2)+1
        u(j+1,i)=(k*delt/(c*rho*delx^2))*(u(j,i-1)+u(j,i+1))+...
            (1-2*k*delt/(c*rho*delx^2))*u(j,i);
    end
    for i=N+1:-1:ceil((N+1)/2)+1
        u(j+1,i)=u(j+1,ceil((N+1)/2)*2-i);
    end
end
t', u
surf(x, t', u(1:Jend+1,:))
xlabel('x'); ylabel('waktu');
zlabel('konsentrasi')
```

09 Parsial Differential Equation

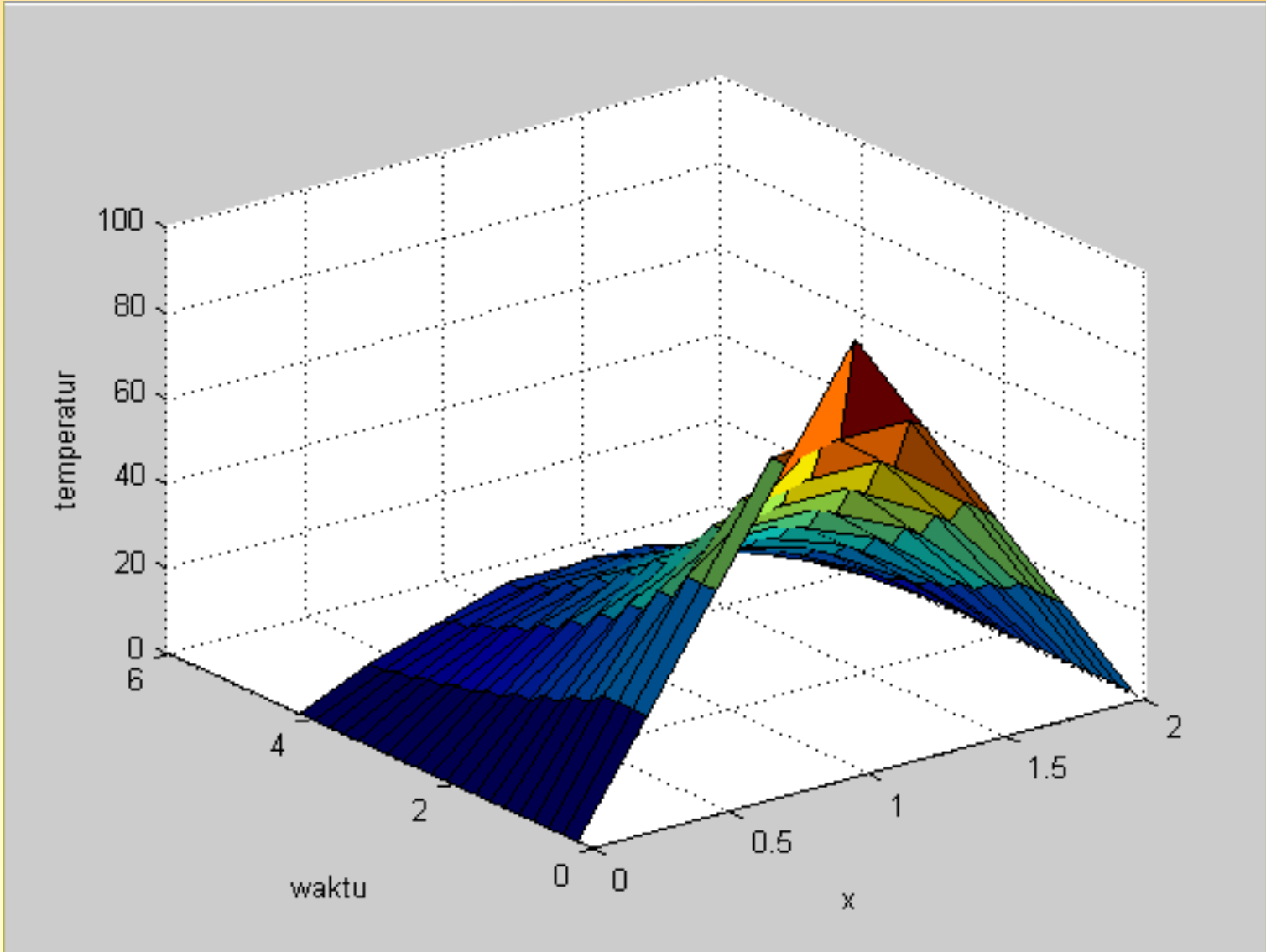

next

Difusi alkohol

Suatu tabung panjang 20 cm mula-mula berisi udara dengan 2 % uap alkohol. Pada bagian bawah tabung berhubungan dengan bejana berisi alkohol sehingga alkohol tersebut menguap melalui tabung yang mula-mula berisi udara diam tersebut. Pada bagian ini konsentrasi alkohol dijaga tetap 10 %. Pada bagian atas (puncak) tabung uap alkohol di permukaan atas tabung dapat dianggap selalu nol.

Tentukan distribusi konsentrasi alkohol pada tabung sampai minimal 1000 detik.
Diketahui $\mathfrak{D} = 0,119 \text{ cm}^2 / \text{detik}$.

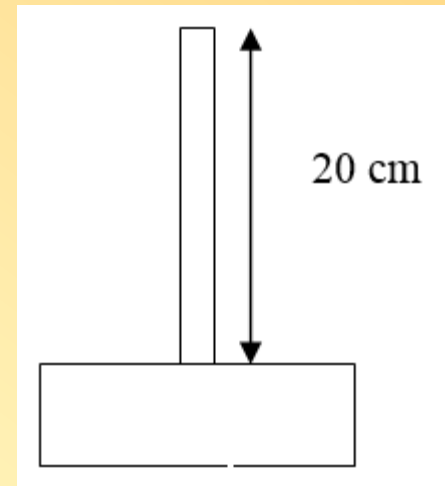

Persamaan Parabolik

$$D \frac{d^2 c}{dx^2} = \frac{dc}{dt}$$

Kondisi awal

$$c(x,0) = 2$$

Kondisi batas

$$c(0,t) = 0 \quad c(20,t) = 10$$

$$r = 9 \Delta t / (\Delta x)^2 = 1/2 \text{ dan } \Delta x = 4 \text{ cm.}$$

$$\Delta t = 0.5(\Delta x)^2 / 9 = 67,2 \text{ detik}$$

$$\frac{\partial^2 u}{\partial x^2} = \frac{u_{i+1}^j - 2u_i^j + u_{i-1}^j}{(\Delta x)^2}$$

$$\frac{\partial u}{\partial t} = \frac{u_i^{j+1} - u_i^j}{\Delta t}$$

```

format short
clc
clear all
% Data-data
L=20;
D=0.119;
N=5;
M=0.5;
delx=L/N;
delt=M/D*delx^2;
xo=0;
Jend=16;
for i=1:N+1
    x(i)=xo+delx*(i-1);
end
x
%Kondisi awal
u(1,1)=0.0;
for i=2:N
    u(1,i)=2;
end
u(1,N+1)=10.0;

```

```

% interval waktu
for i=1:Jend+1
    t(i) = delt*i-delt;
end
t=t'
for j=1:Jend
    u(j+1,1)=0.0;
    for i=2:N
        u(j+1,i)=(delt*D/delx^2)*(u
(j,i-1)+u(j,i+1))+...
(1-2*delt*D/delx^2)*u(j,i);
    end
    u(j+1,N+1)=10.0;
end
u
mesh(x, t, u(1:Jend+1,:))
xlabel('x'); ylabel('waktu');
zlabel('konsentrasi')

```



09 Parsial Differential Equation

```
x =
    0     4     8    12    16    20

t =
 1.0e+003 *
    0
    0.0672
    0.1345
    0.2017
    0.2689
    0.3361
    0.4034
    0.4706
    0.5378
    0.6050
    0.6723
    0.7395
    0.8067
    0.8739
    0.9412
    1.0084
    1.0756

u =
    0     2.0000     2.0000     2.0000     2.0000    10.0000
    0     1.0000     2.0000     2.0000     6.0000    10.0000
    0     1.0000     1.5000     4.0000     6.0000    10.0000
    0     0.7500     2.5000     3.7500     7.0000    10.0000
    0     1.2500     2.2500     4.7500     6.8750    10.0000
    0     1.1250     3.0000     4.5625     7.3750    10.0000
    0     1.5000     2.8438     5.1875     7.2813    10.0000
    0     1.4219     3.3438     5.0625     7.5938    10.0000
    0     1.6719     3.2422     5.4688     7.5313    10.0000
    0     1.6211     3.5703     5.3867     7.7344    10.0000
    0     1.7852     3.5039     5.6523     7.6934    10.0000
    0     1.7520     3.7188     5.5986     7.8262    10.0000
    0     1.8594     3.6753     5.7725     7.7993    10.0000
    0     1.8376     3.8159     5.7373     7.8862    10.0000
    0     1.9080     3.7875     5.8511     7.8687    10.0000
    0     1.8937     3.8795     5.8281     7.9255    10.0000
    0     1.9398     3.8609     5.9025     7.9140    10.0000
```

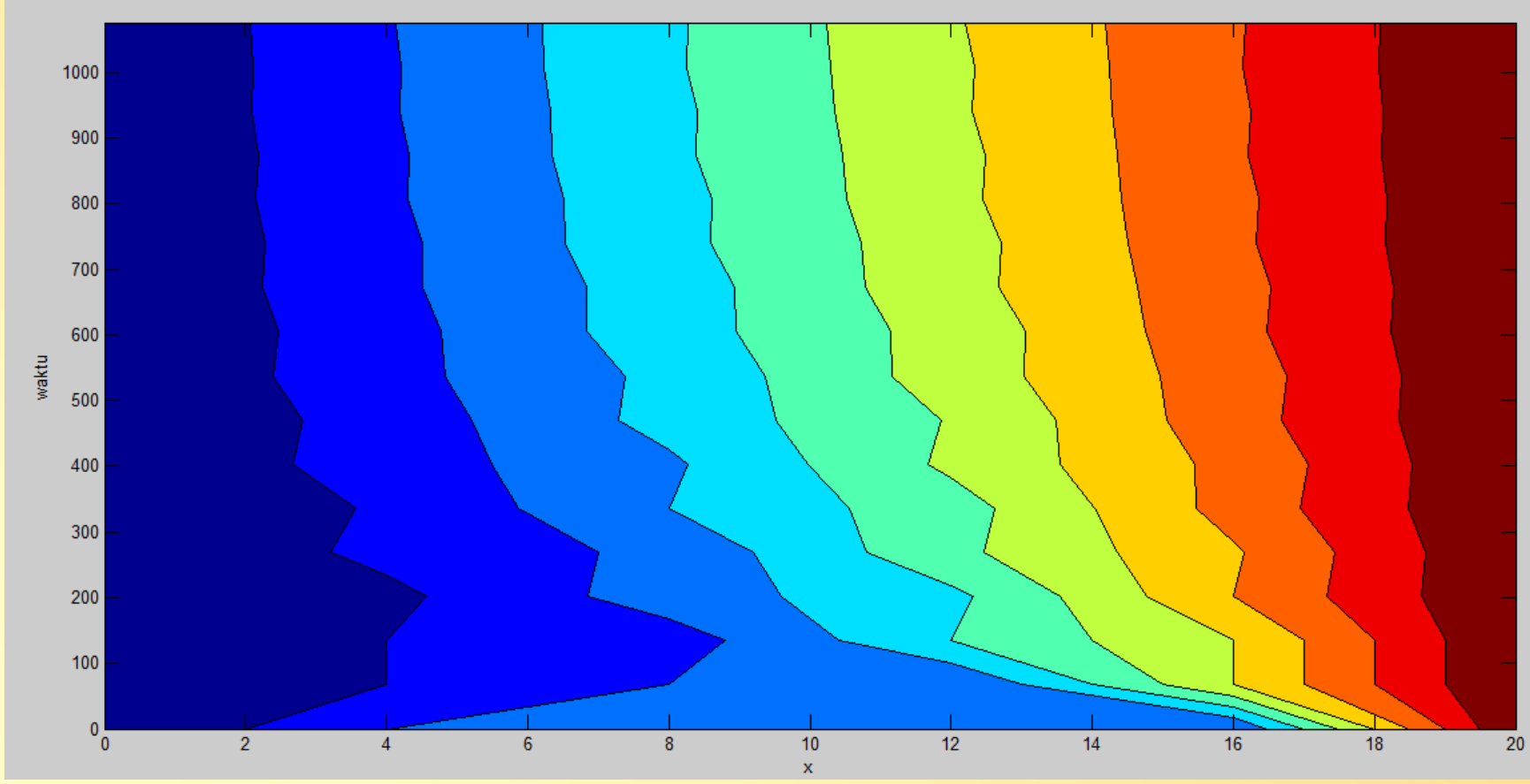
09 Parsial Differential Equation



- Coba untuk $\Delta x = 0.1 \text{ cm}$

00 Partial Differential Equation

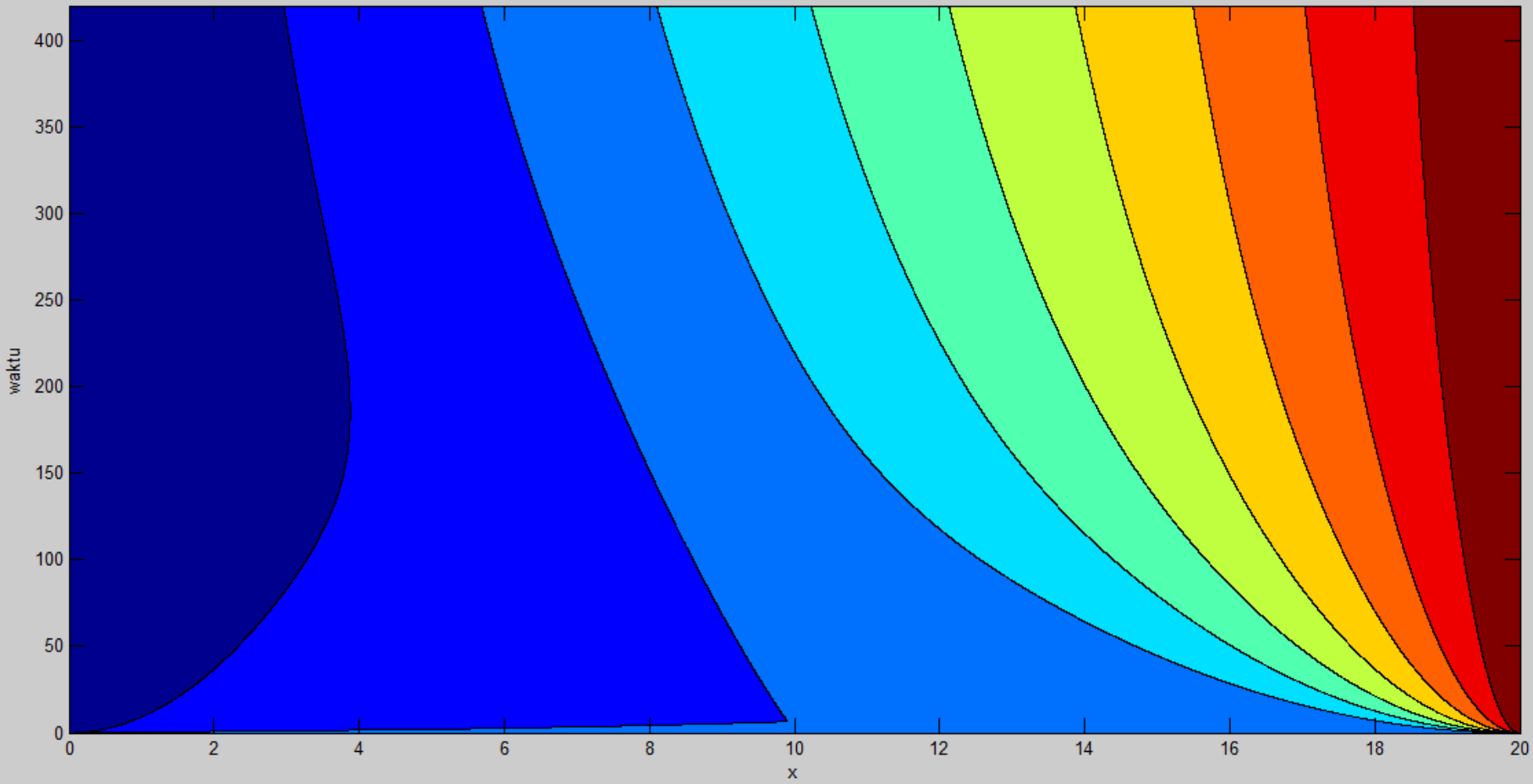

09 Parsial Differential Equation

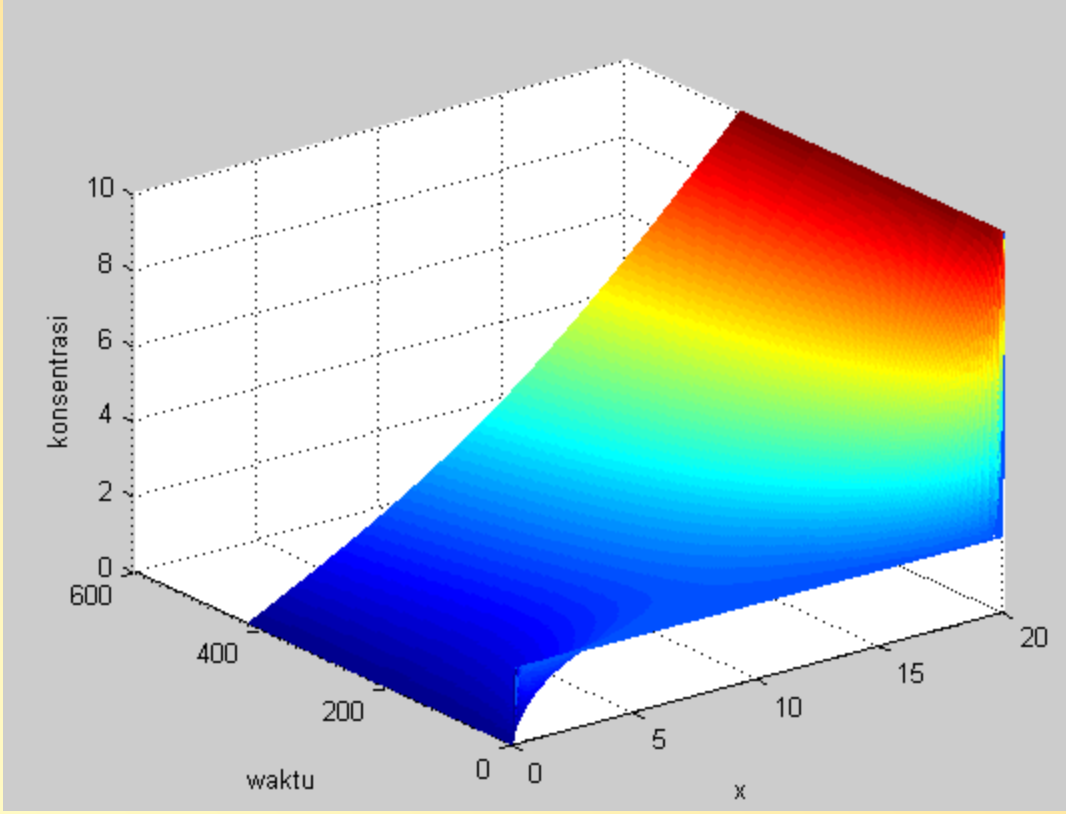

next

Model Problem

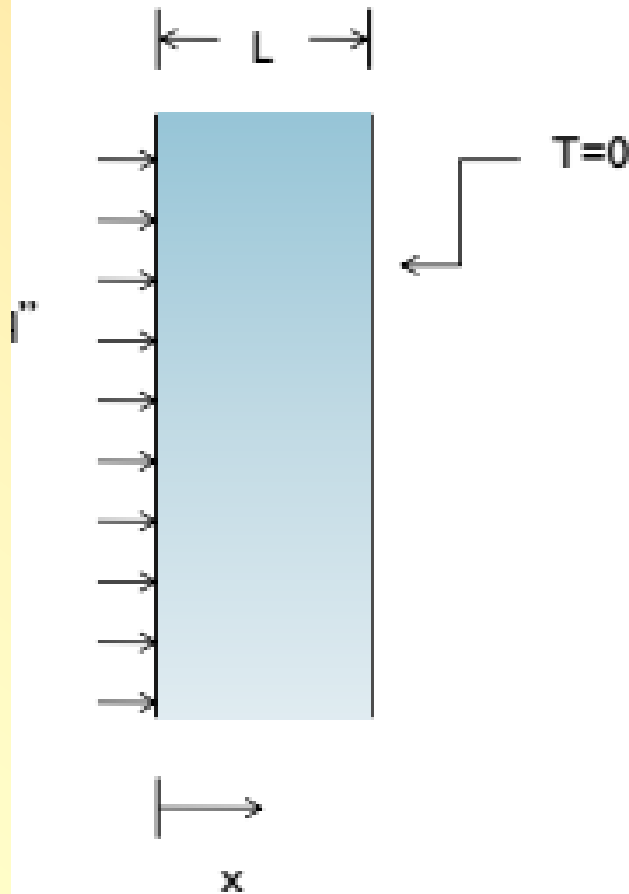

$$\rho c_p \frac{\partial T}{\partial t} = k \frac{\partial^2 T}{\partial x^2}$$

$$T(x, 0) = 0$$

$$-k \frac{\partial T}{\partial x} \Big|_{x=0} = q''$$

$$T(L, t) = 0$$

pdepe Solves the Following

$$c\left(x, t, u, \frac{\partial u}{\partial x}\right) \frac{\partial u}{\partial t} = x^{-m} \frac{\partial}{\partial x} \left(x^m f\left(x, t, u, \frac{\partial u}{\partial x}\right) \right) + s\left(x, t, u, \frac{\partial u}{\partial x}\right)$$

$m=0$ for Cartesian, 1 for cylindrical, 2 for spherical

$$u(x, t_0) = u_0(x)$$

Initial Conditions

$$p(x, t, u) + q(x, t) f\left(x, t, u, \frac{\partial u}{\partial x}\right) = 0$$

Boundary Conditions – one at each boundary

pdepe Solves the Following

$$c\left(x, t, u, \frac{\partial u}{\partial x}\right) \frac{\partial u}{\partial t} = x^{-m} \frac{\partial}{\partial x} \left(x^m f\left(x, t, u, \frac{\partial u}{\partial x}\right) \right) + s\left(x, t, u, \frac{\partial u}{\partial x}\right)$$

$$\rho c_p \frac{\partial T}{\partial t} = k \frac{\partial^2 T}{\partial x^2}$$

$$c = \rho c_p$$

$$f = k \frac{\partial T}{\partial x}$$

$$s = 0$$

Differential Equations

function [c,f,s] = pdex1pde(x,t,u,DuDx)

global rho cp k

c = rho*cp;

f = k*DuDx;

s = 0;

Initial Conditions

function $u_0 = \text{pdexlic}(x)$

$u_0 = 0;$

pdepe Solves the Following

$$-k \left. \frac{\partial T}{\partial x} \right|_{x=0} = q'' \quad p(x,t,u) + q(x,t) f\left(x,t,u, \frac{\partial u}{\partial x}\right) = 0$$

or

$$q'' + k \left. \frac{\partial T}{\partial x} \right|_{x=0} = 0 \quad \begin{array}{l} x=0 \\ p = q'' \\ q = 1 \end{array}$$

remember

$$f = k \frac{\partial T}{\partial x} \quad \begin{array}{l} x=L \\ p = T = ur \\ q = 0 \end{array}$$

$$T(L,t) = 0$$

Boundary Conditions

function [pl,ql,pr,qr] = pdex1bc(xl,ul,xr,ur,t)

global q

pl = q;

ql = l;

pr = ur;

qr = 0;



At left edge, $q+k \cdot dT/dx=0$



At right edge, $ur=0$

09 Parsial Differential Equation

```
function parabolic
global rho cp k
global q
L=0.1 %m
k=200 %W/m-K
rho=10000 %kg/m^3
cp=500 %J/kg-K
q=1e6 %W/m^2
tend=10 %seconds
m = 0;
x = linspace(0,L,20);
t = linspace(0,tend,10);
sol = pdepe(m, @pdex1pde, @pdex1ic, @pdex1bc,x,t);
surfl(x,t,sol)
```

```
function [c,f,s] = pdex1pde(x,t,u,DuDx)
```

```
global rho cp k
```

```
c = rho*cp;
```

```
f = k*DuDx;
```

```
s = 0;
```

```
function u0 = pdex1ic(x)
```

```
u0 = 0;
```

```
function [pl,ql,pr,qr] = pdex1bc(xl,ul,xr,ur,t)
```

```
global q
```

```
pl = q; %these two set  $k \cdot dT/dx - q = 0$  on right side
```

```
ql = 1;
```

```
pr = ur;
```

```
qr = 0; %sets right side temperature to 0
```

09 Parsial Differential Equation

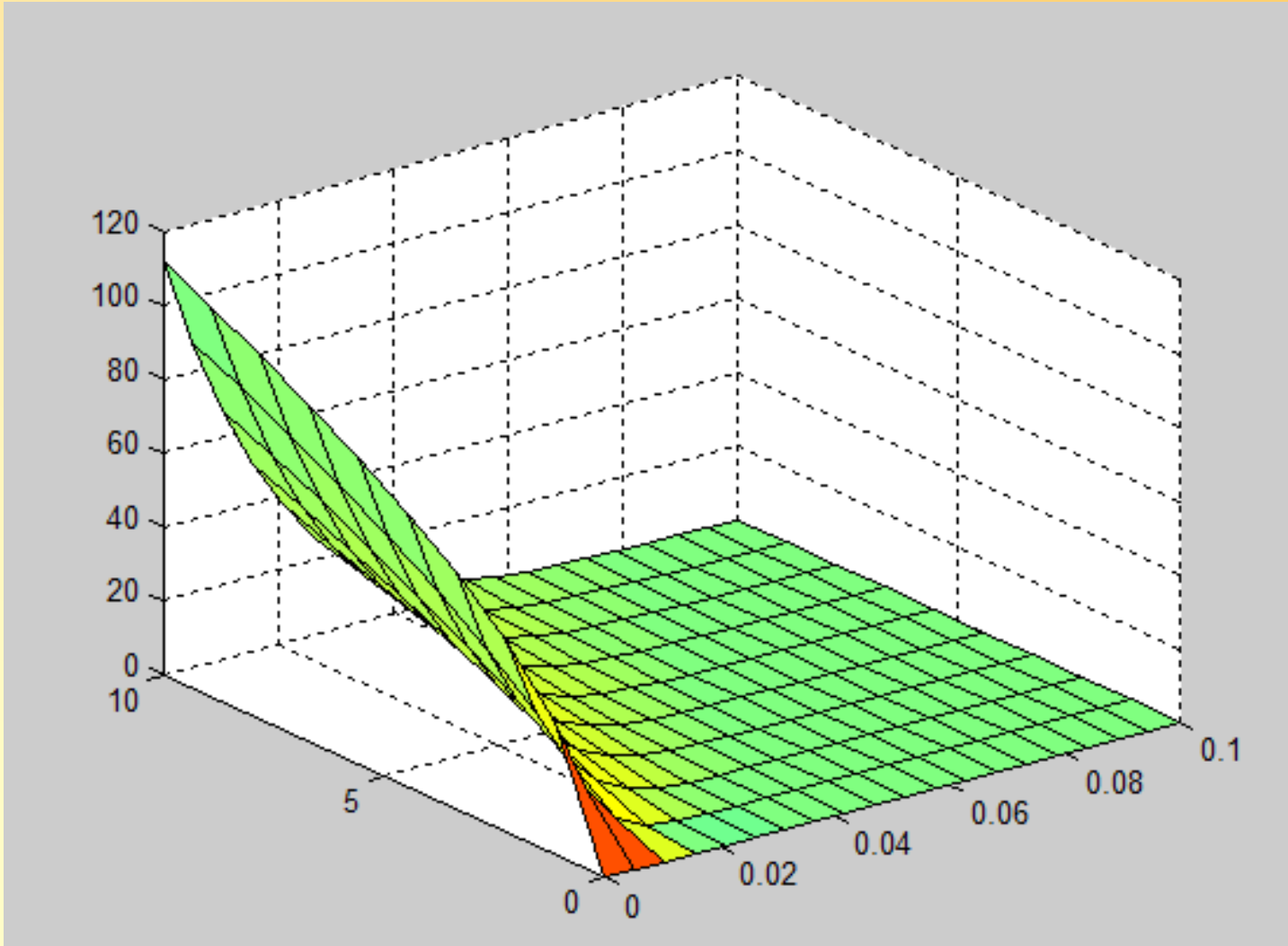

PDEtool

equation solver such as **ode45**. The following specific PDE can be solved with **pdepe**:

$$c \left(x, t, u, \frac{\partial u}{\partial x} \right) \frac{\partial u}{\partial t} = x^{-m} \frac{\partial}{\partial x} \left[x^m f \left(x, t, u, \frac{\partial u}{\partial x} \right) \right] + s \left(x, t, u, \frac{\partial u}{\partial x} \right) \quad (11.3.1)$$

In addition to the PDE, boundary conditions must also be specific. The specific form required for **pdepe** can be nonlinear and time dependent so that:

$$p(x, t, u) + q(x, t)g(x, t, u, u_x) = 0 \text{ at } x = a, b. \quad (11.3.2)$$

PDEtool

To start, consider the simplest PDE: the heat equation:

$$\pi^2 \frac{\partial u}{\partial t} = \frac{\partial^2 u}{\partial x^2} \quad (11.3.3)$$

where the solution is defined on the domain $x \in [0, 1]$ with the boundary conditions

$$u(0, t) = 0 \quad (11.3.4a)$$

$$\pi \exp(-t) + \frac{\partial u(1, t)}{\partial t} = 0 \quad (11.3.4b)$$

and initial conditions

$$u(x, 0) = \sin(\pi x). \quad (11.3.5)$$

M-file : Main command

```
m = 0;  
x = linspace(0,1,20);  
t = linspace(0,2,5);  
u = pdepe(m, 'pdex1pde', 'pdex1ic', 'pdex1bc', x, t);  
surf(x, t, u)
```

Function pdex1pde

$$\pi^2 \frac{\partial u}{\partial t} = \frac{\partial^2 u}{\partial x^2}$$

equation solver such as `ode45`. The following specific PDE can be solved with `pdepe`:

$$c \left(x, t, u, \frac{\partial u}{\partial x} \right) \frac{\partial u}{\partial t} = x^{-m} \frac{\partial}{\partial x} \left[x^m f \left(x, t, u, \frac{\partial u}{\partial x} \right) \right] + s \left(x, t, u, \frac{\partial u}{\partial x} \right) \quad (11.3.1)$$

In this case, the implementation is fairly straightforward since $s(x, t, u, u_x) = 0$, $m = 0$, $c(x, t, u, u_x) = \pi^2$ and $f(x, t, u, u_x) = u_x$. The initial condition is quite easy and can be done in one line.

pdex1pde.m

```
function [c,f,s] = pdex1pde(x,t,u,DuDx)
c = pi^2;
f = DuDx;
s = 0;
```

The initial condition is quite easy and can be done in one line

and initial conditions

$$u(x, 0) = \sin(\pi x).$$

pdex1ic.m

```
function u0 = pdex1ic(x)
u0 = sin(pi*x);
```

the left and right boundaries can be implemented by specifying the function q , q and g at the right and left

$$u(0, t) = 0$$
$$\pi \exp(-t) + \frac{\partial u(1, t)}{\partial t} = 0$$

```
function [pl,q1,pr,qr] = pdex1bc(xl,ul,xr,ur,t)
pl = ul;
q1 = 0;
pr = pi * exp(-t);
qr = 1;
```

09 Parsial Differential Equation

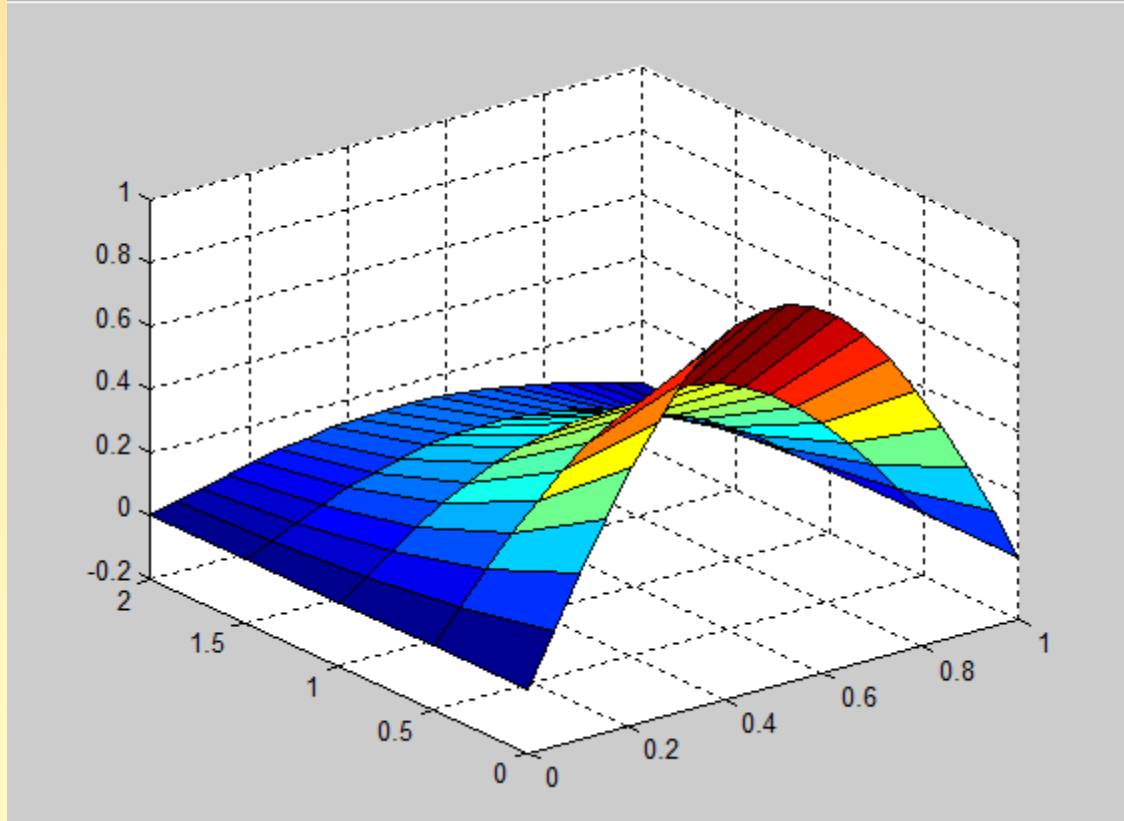

- Selesaikan soal sebelumnya dg PDEtools

Difusi alkohol

Suatu tabung panjang 20 cm mula-mula berisi udara dengan 2 % uap alkohol. Pada bagian bawah tabung berhubungan dengan bejana berisi alkohol sehingga alkohol tersebut menguap melalui tabung yang mula-mula berisi udara diam tersebut. Pada bagian ini konsentrasi alkohol dijaga tetap 10 %. Pada bagian atas (puncak) tabung uap alkohol di permukaan atas tabung dapat dianggap selalu nol.

Tentukan distribusi konsentrasi alkohol pada tabung sampai minimal 1000 detik.
Diketahui $\mathfrak{D} = 0,119 \text{ cm}^2 / \text{detik}$.

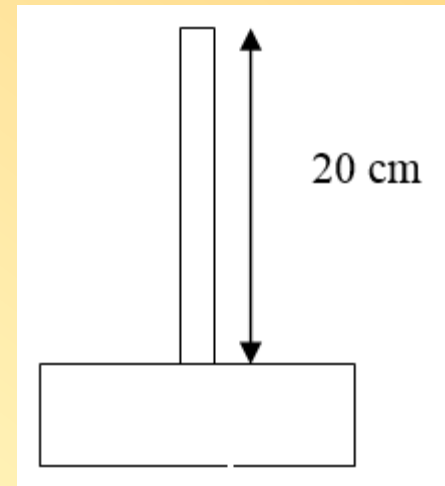

Persamaan Parabolik

$$D \frac{d^2 c}{d x^2} = \frac{d c}{d t}$$

Kondisi awal

$$c(x,0) = 2$$

Kondisi batas

$$c(0,t) = 0 \quad c(20,t) = 10$$

pdepe Solves the Following

$$c\left(x, t, u, \frac{\partial u}{\partial x}\right) \frac{\partial u}{\partial t} = x^{-m} \frac{\partial}{\partial x} \left(x^m f\left(x, t, u, \frac{\partial u}{\partial x}\right) \right) + s\left(x, t, u, \frac{\partial u}{\partial x}\right)$$

$m=0$ for Cartesian, 1 for cylindrical, 2 for spherical

$$u(x, t_0) = u_0(x)$$

Initial Conditions

$$p(x, t, u) + q(x, t) f\left(x, t, u, \frac{\partial u}{\partial x}\right) = 0$$

Boundary Conditions – one at each boundary

The Main file

```
m = 0;  
x = linspace(0, 20, 201);  
t = linspace(0, 500, 501)  
u = pdepe(m, 'pdex3pde', 'pdex3ic', 'pdex3bc', x, t);  
mesh(x, t, u)
```

function [c,f,s] = pdex3pde(x,t,u,DuDx)

c = 1/0.119;

f = DuDx;

s = 0;

function $u_0 = \text{pdex3ic}(x)$

$u_0 = 2;$

function [p1,q1,pr,qr] = pdex3bc(x1,u1,xr,ur,t)

p1 = u1;

q1 = 0;

pr = ur-10;

qr = 0;

09 Parsial Differential Equation

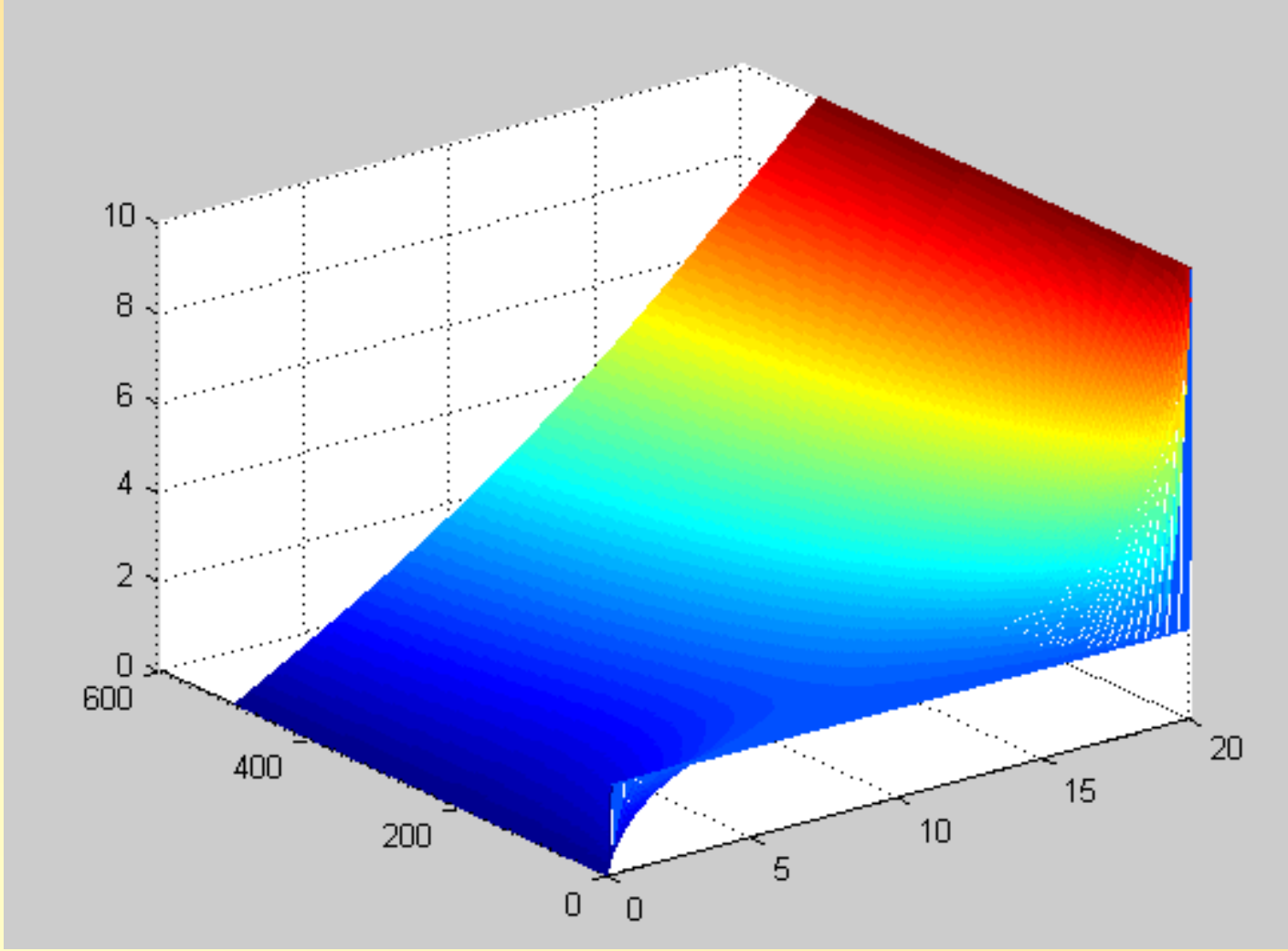

the transient behavior of a rod at constant T put between two heat reservoirs at different temperatures, again $T_1 = 100$, and $T_2 = 200$. The rod will start at 150. Over time, we should expect a solution that approaches the steady state solution: a linear temperature profile from one side of the rod to the other.

$$\frac{\partial u}{\partial t} = k \frac{\partial^2 u}{\partial x^2}$$

$$t = 0; T_0(x) = 150$$

$$T(0, t) = 100$$

$$T(L, t) = 200$$

```
m=0; % specifies 1-D symmetry
x = linspace(0,1); % equally-spaced points along the length of the rod
t = linspace(0,5); % this creates time points
sol = pdepe(m,@pdex,@pdexic,@pdexbc,x,t);
surf(x,t,sol)
xlabel('Position')
ylabel('time')
zlabel('Temperature')
```

```
function [c,f,s] = pdex(x,t,u,DuDx)
c = 1;
f = 0.02*DuDx;
s = 0;
```

```
function u0 = pdexic(x)
u0 = 150;
```

```
function [pl,ql,pr,qr] = pdexbc(xl,ul,xr,ur,t)
pl = u1-100;
ql = 0;
pr= ur-200;
qr = 0;
```

A Second Problem

- Suppose we want convection at $x=L$
- That is

$$p(x, t, u) + q(x, t) f\left(x, t, u, \frac{\partial u}{\partial x}\right) = 0$$

$$-k \frac{dT}{dx} = h(T - T_{bulk})$$

or

$$hT - hT_{bulk} + k \frac{dT}{dx} = 0$$

$$x = L$$

$$p = T = h(ur - T_{bulk})$$

$$q = 1$$

Diffusion Equation

$$\frac{\partial c}{\partial t} = D \frac{\partial^2 c}{\partial x^2}$$

Initial Condition

$$C(x, 0) = 0$$

Boundary Conditions

$$C(0, t) = C_{max}$$

$$\frac{\partial c}{\partial x}(L, t) = 0$$

The diffusion equation as derived earlier can be written as

$$\frac{\partial c}{\partial t} = D_x \frac{\partial^2 c}{\partial x^2} \quad (37.4)$$

Initial condition

$$C(x, t = 0) = 0 \quad (37.5)$$

Boundary conditions

$$C(x = 0, t) = C_o \quad (37.6)$$

$$C(x = \infty, t) = 0 \quad (37.7)$$

Comparing (37.4) with (37.1), we have

$$g\left(x, t, c, \frac{\partial c}{\partial x}\right) = 1 \quad (37.6)$$

$$f\left(x, t, c, \frac{\partial c}{\partial x}\right) = D_x \frac{\partial c}{\partial x} \quad (37.7)$$

$$s\left(x, t, c, \frac{\partial c}{\partial x}\right) = 0 \quad (37.8)$$

$$m = 1 \quad (37.9)$$

Comparing (37.5) with (37.2), we have

$$co = 0 \quad (37.10)$$

Comparing (37.6) and (37.7) with (37.2), we have

$$pl = cl - 1 \quad (37.11)$$

$$ql = 0 \quad (37.12)$$

$$pr = cr \quad (37.13)$$

$$qr = 0 \quad (37.14)$$

09 Parsial Differential Equation

```
function [g,f,s] = pdefun_ex1(x,t,c,DcDx)
    D=0.0000972;
    g = 1;
    f = D*DcDx;
    s = 0;
end
```

Function icfun

```
function c0 = icfun_ex1(x)
    c0 = 0;
end
```

Function bcfun

```
function [p1,q1,pr,qr] = bcfun_ex1(x1,c1,xr,cr,t)
    p1 = c1-1;
    q1 = 0;
    pr = cr;
    qr = 0;
end
```

09 Parsial Differential Equation

```
clear all;
Close all;

m = 0;
x = linspace(0,2.5,200); % Spatial discretization
t = linspace(0,730,100); % Temporal descretization

sol = pdepe(m,@pdefun_ex1,@icfun_ex1,@bcfun_ex1,x,t);

% The following loop is for plotting the result

for i=10:10:100
    plot(x,sol(i,:), 'color', [rand rand rand]);
    axis tight;
    xlabel('X');
    ylabel('C/Co');
    hold on;
end
```

09 Parsial Differential Equation

```
%-----functions-----  
function [c,f,s] = transfun(x,t,u,DuDx,D,v,c0,cin)  
c = 1;  
f = D*DuDx;  
s = -v*DuDx;  
%-----  
function u0 = ictransfun(x,D,v,c0,cin)  
u0 = c0;  
%-----  
function [pl,ql,pr,qr] = bctransfun(xl,ul,xr,ur,t,D,v,c0,cin)  
pl = ul-cin;  
ql = 0;  
pr = 0;  
qr = 1;
```

09 Parsial Differential Equation

```
function pdepetrans
% transport-solver using 'pdepe'

T = 4.;           % maximum time [s]
L = 2.5;         % length [m]
D = 0.01;       % diffusivity [m^2/s]
v = 1;          % velocity [m/s]
c0 = 0;         % initial concentration [kg/m^3]
cin = 1;        % boundary concentration [kg/m^3]
M = 100;        % number of timesteps
N = 100;        % number of nodes

t = linspace (T/M,T,M); % time discretization
x = linspace (0,L,N);   % space discretization

%-----execution-----
options = odeset;
c = pdepe (0,@transfun,@ictransfun,@bctransfun,x,...
[0 t],options,D,v,c0,cin);

%----- output -----
plot ([0 t],c)           % breakthrough curves
      xlabel ('time'); ylabel ('concentration');
```

Example 1: A Mass Transfer System

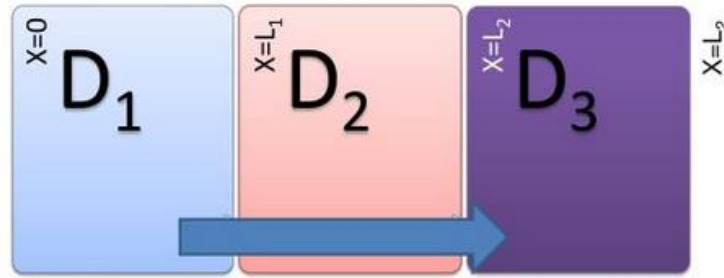

$$\frac{\partial C}{\partial t} = D \frac{\partial^2 C}{\partial x^2}$$

Initial Conditions

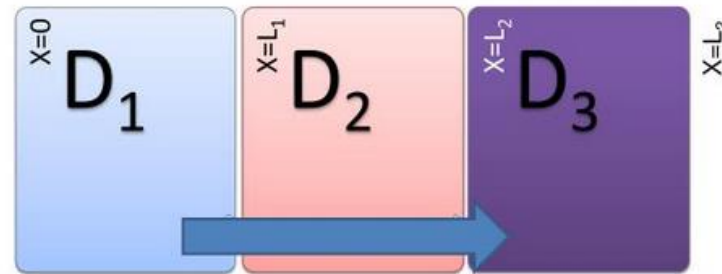

@ t=0

$$0 \leq x \leq L_1$$

$$C = C_0$$

$$L_1 \leq x \leq L_2$$

$$C = 0$$

$$L_2 \leq x \leq L_3$$

$$C = 0$$

Boundary Conditions

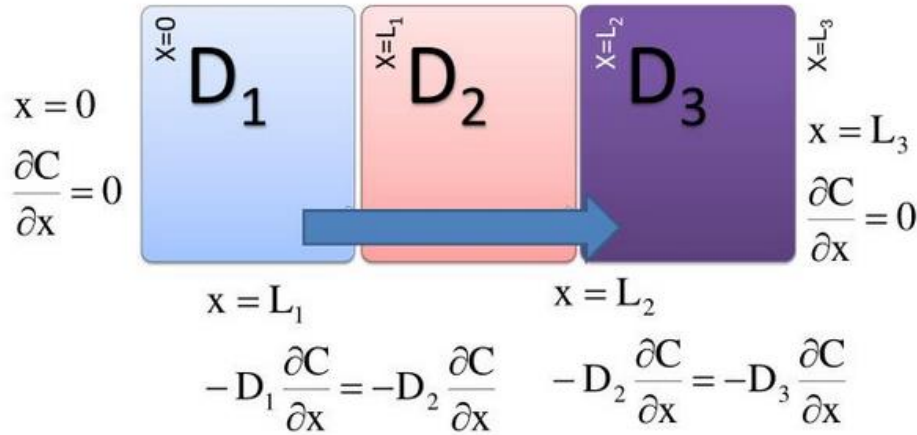

$$c(x, t, u, \frac{\partial u}{\partial x}) \frac{\partial u}{\partial t} = x^{-m} \frac{\partial}{\partial x} (x^m b(x, t, u, \frac{\partial u}{\partial x})) + s(x, t, u, \frac{\partial u}{\partial x})$$

$$\frac{\partial C}{\partial t} = D \frac{\partial^2 C}{\partial x^2}$$

$$c(x, t, u, u_x) = 1$$

$$m = 0$$

$$b(x, t, u, u_x) = D_1 \cdot \frac{\partial C}{\partial x} = D_1 \cdot u_x$$

$$s(x, t, u, u_x) = 0$$

09 Parsial Differential Equation

$$\begin{aligned}
 &x = 0, \quad \frac{\partial C}{\partial x} = 0 \quad p(xl, t, u) + q(xl, t).b(xl, t, u, u_x) = 0 \\
 &b = D_1 \cdot \frac{\partial C}{\partial x} \quad \boxed{p(0, t, u) = 0} \quad \boxed{q(0, t) = \frac{1}{D_1}} \\
 &x = L_1, \quad -D_1 \frac{\partial C}{\partial x} = -D_2 \frac{\partial C}{\partial x} \text{ or} \\
 &x = L_1, \quad \frac{(D_2 - D_1)}{D_1} D_1 \frac{\partial C}{\partial x} = 0 \quad \boxed{D_1 \cdot \frac{\partial C}{\partial x}} \\
 &\quad p(xr, t, u) + q(xr, t).b(xr, t, u, u_x) = 0 \\
 &\quad \boxed{p(L_1, t, u) = 0} \quad \boxed{q(L_1, t) = \frac{D_2 - D_1}{D_1}}
 \end{aligned}$$

10

$$u(0, x) = f(x)$$

$$C(0, x) = C_0$$

$$u(0, x) = C_0$$

09 Parsial Differential Equation

```
function [c,b,s] = system(x,t,u,DuDx)
    c = 1;
    b =D1*DuDx;
    s = 0;
end
```

```
function [pl,ql,pr,qr] =
    bcl(xl,ul,xr,ur,t)
```

```
pl = 0;
ql = 1/D1;
pr = 0;
qr = (D2-D1)/D1;
end
```

```
function value = initial1(x)
```

```
value = C0;
```

```
end
```

```
m = 0;
%Define the solution mesh
x = linspace(0,1,20);
t = linspace(0,2,10);
%Solve the PDE
u = pdepe(m,@system,@initial1,@bcl,x,t);
%Plot solution
surf(x,t,u);
title('Surface plot of solution. ');
xlabel('Distance x');
ylabel('Time t');
```

Results

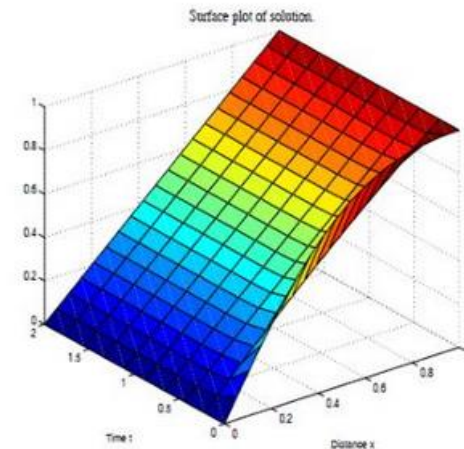

Example 2.39: One-Dimensional Parabolic PDE

The temperature $u(x, t)$ in a wall of unit length can be described by the one-dimensional heat equation

$$\frac{\partial u}{\partial t} = \alpha \frac{\partial^2 u}{\partial x^2}$$

The thickness of the wall is 1 m and the initial profile of the temperature in the wall at $t = 0$ sec is uniform at $T = 90^\circ\text{C}$. At time $t = 0$, the ambient temperature is suddenly changed to 15°C and held there. If we assume that there is no convection resistance, the temperature of both sides of the wall is also held constant at 15°C . Determine the temperature distribution graphically within the wall from $t = 0$ to $t = 21,600$ sec. The wall property can be assumed as $\alpha = 4.8 \times 10^{-7}$ m/sec².

Solution

Step 1: From the heat equation, we have $((1/\alpha)(\partial u/\partial t)) = (\partial^2 u/\partial x^2)$. Thus, we can see that $m = 0$, $g = 1/\alpha$, $f = \partial u/\partial x$, and $r = 0$. Create a function that holds g , f , and r :

```
function [g, f, r] = pdeTde(x, t, u, DuDx)
alpha = 4.8e-7;
g = 1/alpha;
f = DuDx;
r = 0;
end
```



```
function u0 = pdeTic(x)
u0 = 90;
end
```

Step 3: Specify the boundary conditions $p(x, t, u) + q(x, t)f(x, t, u, (\partial u/\partial x)) = 0$. Since the temperature at both sides of the wall is 15°C, $p = p_l = u_l - 15$ and $q = q_l = 0$ at $x = 0$, and $p = p_r = u_r - 15$ and $q = q_r = 0$ at $x = 1$. Create a function that holds these boundary conditions.

```
function [p1,q1,pr,qr] = pdeTbc(xl,ul,xr,ur,t)
p1 = ul-15;
q1 = 0;
pr = ur-15;
qr = 0;
end
```

Step 4: Set the intervals for x and t , and call the function *pdepe* to solve the equation. Suppose that the range of x is divided into 20 subintervals and the time span is divided into 180 subintervals. The following script generates the temperature profile in the wall as shown in [Figure 2.21](#):

```
>> m = 0; x = linspace(0,1,20);
>> t = linspace(0,21600,54);
```

09 Partial Differential Equation

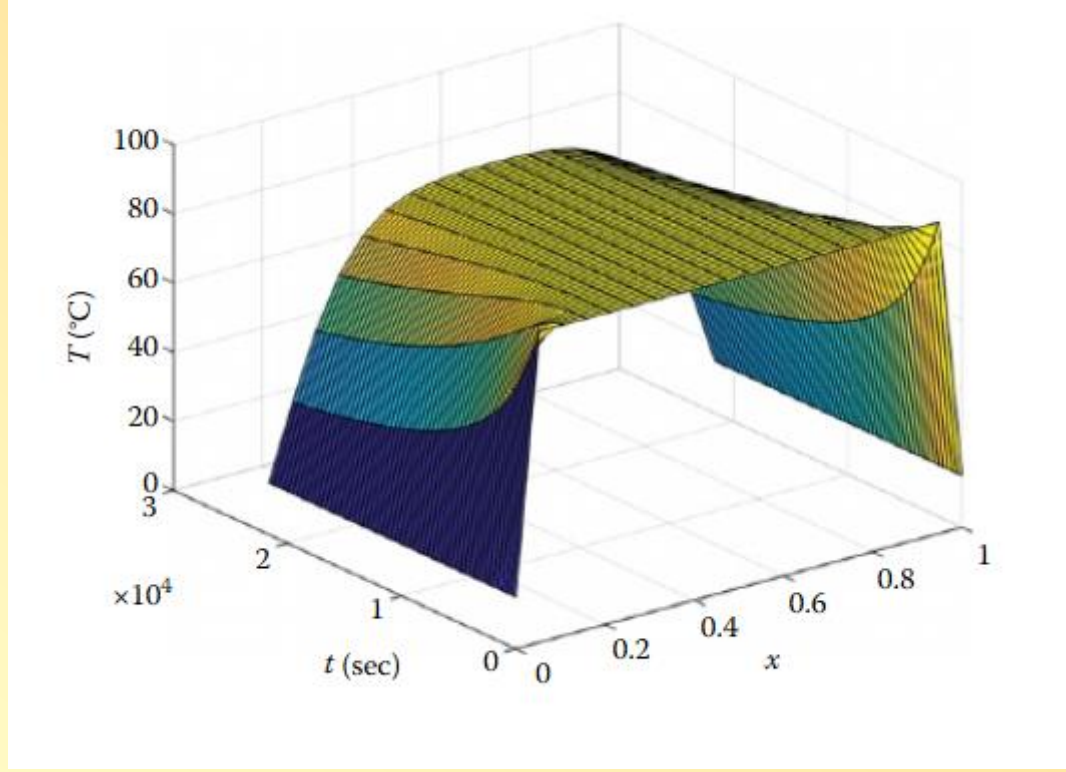

next

- MATLAB can perform symbolic calculus on expressions. Consider the following example:

```
syms x  
f=sin(x^2)  
f =  
sin(x^2)  
diff(f,x)  
ans =  
2*x*cos(x^2)
```

```
syms x y
```

```
q=x^2*y^3*exp(x)
```

```
q =
```

```
x^2*y^3*exp(x)
```

```
pretty(q)
```

```
  2 3
```

```
x y exp(x)
```

```
diff(q,y)
```

```
ans =
```

```
3*x^2*y^2*exp(x)
```

```
syms a t
```

```
u=exp(a*t)
```

```
u =
```

```
exp(a*t)
```

```
diff(u,t)
```

```
ans =
```

```
a*exp(a*t)
```

check whether the function $u(t)=e^{at}$ is a solution of the ODE

$$\frac{du}{dt} - au = 0.$$

syms a t

u=exp(a*t)

u =

exp(a*t)

diff(u,t)-a*u

ans =

0

$w(x,y)=\sin(\pi x)+\sin(\pi y)$ a solution of the differential equation

$$\frac{\partial^2 u}{\partial x^2} + \frac{\partial^2 u}{\partial y^2} = 0?$$

```
syms x y
```

```
w=sin(pi*x)+sin(pi*y)
```

```
w =
```

```
sin(pi*x) + sin(pi*y)
```

```
diff(w,x,2)+diff(w,y,2)
```

```
ans =
```

```
- pi^2*sin(pi*x) - pi^2*sin(pi*y)
```

```
simplify(ans)
```

```
ans =
```

```
-pi^2*(sin(pi*x) + sin(pi*y))
```

Since the result is not zero, the function w is not a solution of the PDE

To compute a mixed partial derivative, we have to iterate the **diff** command. Here is the mixed partial derivative of $w(x,y)=x^2+xy^2$ with respect to x and then y :

```
syms x y
```

```
w=x^2*exp(y)+x*y^2
```

```
w =
```

```
x^2*exp(y) + x*y^2
```

```
diff(diff(w,x),y)
```

```
ans =
```

```
2*y + 2*x*exp(y)
```

can use functions. Consider the following

```
clear
```

```
syms a x
```

```
f=@(x)exp(a*x)
```

```
f =
```

```
@(x)exp(a*x)
```

```
f(1)
```

```
diff(f(x),x)-a*f(x)
```

```
ans =
```

```
0
```

09 Parsial Differential Equation

```
syms x
```

```
f=x^2
```

```
f =
```

```
x^2
```

```
int(f,x)
```

```
ans =
```

```
x^3/3
```

To compute a definite integral

int(x²,x,0,1)

ans =

1/3

```
f=@(x)exp(cos(x))
```

```
f =
```

```
@(x)exp(cos(x))
```

```
quad(f,0,1)
```

```
ans =
```

```
2.3416
```

"quad" is short for quadrature, another term for numerical integration

$$\frac{d}{dx} \int_c^d F(x, y) dy = \int_c^d \frac{\partial F}{\partial x}(x, y) dy.$$

syms x y c d

f=x*y^3+x^2*y

f =

x^2*y + x*y^3

r1=diff(int(f,y,c,d),x)

r1 =

-(x*(c^2 - d^2))/2 - ((c^2 - d^2)*(c^2 + d^2 + 2*x))/4

r2=int(diff(f,x),y,c,d)

r2 =

-((c^2 - d^2)*(c^2 + d^2 + 4*x))/4

r1-r2

ans =

((c^2 - d^2)*(c^2 + d^2 + 4*x))/4 - ((c^2 - d^2)*(c^2 + d^2 + 2*x))/4 -

(x*(c^2 - d^2))/2

simplify(ans)

ans =

0

The MATLAB solve command

- to solve the linear equation $ax+b=0$ for x .

```
syms f x a b
```

```
f=a*x+b
```

```
f =
```

```
b + a*x
```

```
solve(f,x)
```

```
ans =
```

```
-b/a
```

To solve $x^2-3*x+2=0$

syms f x

f=x^2-3*x+2;

solve(f,x)

ans =

1

2

to solve the equations

$$x+y=1$$

$$2x-y=1$$

syms x y

s=solve(x+y-1,2*x-y-1,x,y)

s.x

ans =

2/3

s.y

ans =

1/3

```
s=solve(x^2+y^2-1,y-x^2,x,y)
```

```
s =
```

```
x: [4x1 sym]
```

```
y: [4x1 sym]
```

The first solution is

```
pretty(s.x(1))
```

```
pretty(s.y(1))
```

The second solution is

```
pretty(s.x(2))
```

```
pretty(s.y(2))
```

```
clear
syms u1 u2 u3
u1=sym([1;0;2]);
u2=sym([0;1;1]);
u3=sym([1;2;-1]);
A=[u1,u2,u3]
```

```
A =
[ 1, 0, 1]
[ 0, 1, 2]
[ 2, 1, -1]
```

```
b=sym([8;2;-4]);
x=A\b
x =
18/5
-34/5
22/5
```